

Safety Information

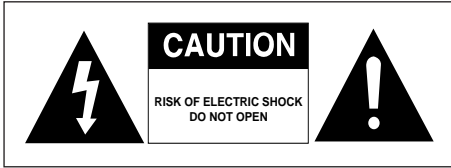

TO REDUCE THE RISK OF ELECTRIC SHOCK, DO NOT REMOVE THE COVER(OR BACK). NO USER-SERVICEABLE PARTS ARE INSIDE. REFER SERVICING TO QUALIFIED SERVICE PERSONNEL.

WARNING

To reduce the risk of fire or shock hazard, do not expose this DVD player to rain or moisture.

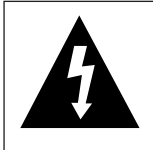

This symbol indicates "dangerous voltage" inside the product that presents a risk of electric shock or personal injury.



This symbol indicates important instructions accompanying the product.

CAUTION

THIS PRODUCT UTILIZES A LASER. USE OF CONTROLS OR ADJUSTMENTS OR PERFORMANCE OF PROCEDURES OTHER THAN THOSE SPECIFIED HEREIN MAY RESULT IN HAZARDOUS RADIATION EXPOSURE. DO NOT OPEN COVER AND DO NOT REPAIR YOURSELF. REFER SERVICING TO QUALIFIED PERSONNEL.

CAUTION: DVD PLAYERS USE AN INVISIBLE LASER BEAM WHICH CAN CAUSE HAZARDOUS RADIATION EXPOSURE IF DIRECTED. BE SURE TO OPERATE PLAYER CORRECTLY AS INSTRUCTED.

CAUTIONS

Caution: To prevent electric shock, match wide blade of plug to wide slot, fully insert.

Attention: Pour éviter les chocs électriques, introduire la lame la plus large de la fiche dans la borne correspondante de la prise et pousser jusqu'au fond.

This product satisfies FCC regulations when shielded cables and connectors are used to connect the unit to other equipment. To prevent electromagnetic interference with electric appliances, such as radios and televisions, use shielded cables and connectors for connections.

FCC NOTE (for U.S.A):

This equipment has been tested and found to comply with the limits for a Class B digital device, pursuant to Part 15 of the FCC rules. These limits are designed to provide reasonable protection against harmful interference in a residential installation. This equipment generates, uses and can radiate radio frequency energy and, if not installed and used in accordance with the instructions, may cause harmful interference to radio or television reception, which can be determined by turning the equipment off and on, the user is encouraged to try to correct the interference by one or more of the following measures.

- Reorient or relocate the receiving antenna.
- Increase the separation between the equipment and receiver.
- Connect this equipment into an outlet on a circuit different from that to which the receiver is connected.
- Consult the dealer or an experienced radio/TV technician for help.

This class B digital apparatus meets all requirements of the Canadian Interference -- Causing Equipment Regulations.

Note:

- This unit can be used only where the power supply is AC 120V, 60Hz. It cannot be used elsewhere.
- This DVD player is designed and manufactured to respond to the Region Management Information. If the Region number of a DVD disc does not correspond to the Region number of this DVD player, this DVD player cannot play the disc.
- This device is protected by U.S. patent numbers 4,631,603 and 4,577,216 and 4,819,098 and other intellectual property rights. The use of Macrovision's copy protection technology in the device must be authorized by Macrovision and is intended for home and other limited pay-per-view uses only, unless otherwise authorized in writing by Macrovision. Reverse engineering or disassembly is prohibited.

**CLASS 1 LASER PRODUCT
LUOKAN 1 LASER LAITE
KLASS 1 LASER APPARAT**

Care & Maintenance

For trouble free operation, follow the instructions shown below.

Handling Cautions

- Before connecting other components to this player, be sure to turn them all off.
- Do not move the player while a disc is being played, or the disc may be scratched or broken, and the player's internal parts may be damaged.
- Do not put a flower vase filled with water or any small metal objects on the player.
- Be careful not to put your hand into the disc tray.
- Do not place anything other than the disc in the disc tray.
- Exterior interference such as lightning and static electricity can affect normal operation of this player. If this occurs, turn the player off and on again with the POWER button, or disconnect and then reconnect the AC power cord to the AC power outlet. The player will operate normally.
- Be sure to remove the disc and turn off the player after use.
- Disconnect the AC power cord from the AC outlet when you don't intend to use the player for long periods of time.
- Clean the disc by wiping in a straight line from the inside to the outside of the disc.

Disc Storage

Be careful not to harm the disc because the data on these discs is highly vulnerable to the environment.

- Do not keep under direct sunlight.
- Keep in a cool ventilated area.
- Store vertically.
- Keep in a clean protection jacket.

Maintenance of Cabinet

For safety reasons, be sure to disconnect the AC power cord from the AC outlet.

- Do not use benzene, thinner, or other solvents for cleaning.
- Wipe the cabinet with a soft cloth.

Accessories

Remote Control

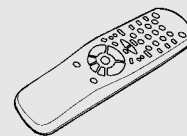

Batteries for Remote Control (AA Size)

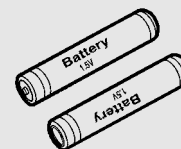

Video/Audio Connection Cable

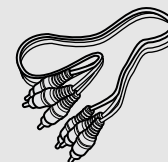

S-Video Cable

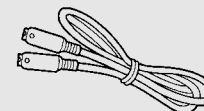

User's Manual



Registration Card



Formation of Condensation

Due to sharp changes in temperature and humidity, condensation may form if warm air comes in contact with any cold parts inside the player.

- When condensation forms inside the player, the player may not operate correctly. If this occurs, leave the player at room temperature until the inside of the player becomes dry and operational.
- If condensation forms on a disc, wipe the disc with a soft and dry cloth by moving the cloth from the center hole toward the outer edge.



TABLE OF CONTENTS

Disc Features	6	• Rear Panel (DVD-909)	10
Disc Type and Characteristics	7	• Rear Panel (DVD-709).....	11
Description	8	A Tour of the Remote Control	12
• Front Panel (DVD-909)	8	• DVD Function Buttons	12
• Front Panel (DVD-709)	9	• TV Function Buttons	13

Choosing a Connection (DVD-909)	14	Choosing a Connection (DVD-709)	16
• Connecting to a TV	14	• Connecting to a TV	16
• Connecting to an Audio System	15	• Connecting to an Audio System	17

Playing a Disc	18	Repeat Play	22
Searching & Skipping through a Chapter or Track.....	20	Using the A-B Repeat Function	23
Using the Display Function	21	Program Playback in a Specific Order	24

Using the Disc View Function	25	Selecting the Desired Screen Angle	28
Selecting Audio	26	Using the Bookmark Function	29
Selecting the Subtitle Language	27	Using the Zoom and 3D Sound Functions	30

Using the Setup Menu	31	Setting Up Audio Options	35
Setting Up the Language Features	32	Surround Sound Speaker Setup (DVD-909 only).....	36
Setting Up the Parental Level	34	Setting Up Display Options	37

Controlling a TV with the Remote	38	Specifications (DVD-709)	41
Troubleshooting Guide	39	Warranty	42
Specifications (DVD-909)	40		

Disc Features

Excellent Sound

The Dolby Digital system developed by Dolby Labs provides crystal clear sound reproduction.

Screen

Video with MPEG2 compression technology. Both regular and widescreen(16:9) pictures can be viewed.

Slow Motion

An important scene can be viewed in slow motion.

Programmed Play

You can program tracks to play in desired order.

Parental Level Control

The parental level control allows users to set the level necessary to prohibit children from viewing harmful movies such as those with violence, adult subject matter, etc.

Various On-Screen Menu Functions

You can select various languages(Audio/Subtitle) and screen angles while enjoying movies.

Repeat

You can repeat a song or movie simply by pressing the REPEAT button.









COPY PROTECTION

- Many DVD discs are encoded with copy protection. Because of this, you should only connect your DVD player directly to your TV, not to a VCR. Connecting to a VCR results in a distorted picture from copy-protected DVD discs.
- This product incorporates copyright protection technology that is protected by methods claims of certain U.S. patents and other intellectual property rights owned by Macrovision Corporation and other rights owners. Use of this copyright protection technology must be authorized by Macrovision Corporation, and is intended for home and other limited viewing uses only unless otherwise authorized by Macrovision Corporation. Reverse engineering or disassembly is prohibited.

Disc Type and Characteristics

This DVD player is capable of playing the following types of discs with the corresponding logos:

Disc Types	Logos	Recording Types	Disc Size	Max. Playing Time	Characteristics
DVD 		Audio + Video	5 inches	Single-sided 240 min. Double-sided 480 min.	<ul style="list-style-type: none"> DVD contains excellent sound and video due to Dolby Digital and MPEG2 system. Various screen and audio functions can be easily selected through the on-screen menu.
			3 1/2 inches	Single-sided 80 min. Double-sided 160 min.	
VIDEO-CD 		Audio + Video	5 inches	74 min.	<ul style="list-style-type: none"> Video with CD sound, VHS quality & MPEG1 compression technology.
			3 1/2 inches	20 min.	
AUDIO-CD 		Audio	5 inches	74 min.	<ul style="list-style-type: none"> An LP is recorded as an analog signal with more distortion. CD is recorded as a Digital Signal with better audio quality, less distortion and less deterioration of audio quality over time.
			3 1/2 inches	20 min.	

*DO NOT play CD-ROM, CD-I, CD-R and DVD-ROM in this player! (CDGs play audio only, not graphics.)

Disc Markings

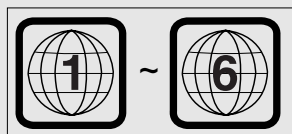

• Playback Region Number

NTSC

• NTSC broadcast system in U.S.A, Canada, Korea, Japan, etc.

DOLBY DIGITAL

• Dolby Digital disc

DIGITAL SOUND

• Digital Audio disc

STEREO

• Stereo disc

dts

• DTS disc

Playback Region Number

Both the DVD player and the discs are coded by region. These regional codes must match in order for the disc to play. If the codes do not match, the disc will not play.

The Region Number for this player is described on the rear panel of the player.

Description-Front Panel DVD-909

Front Panel Controls

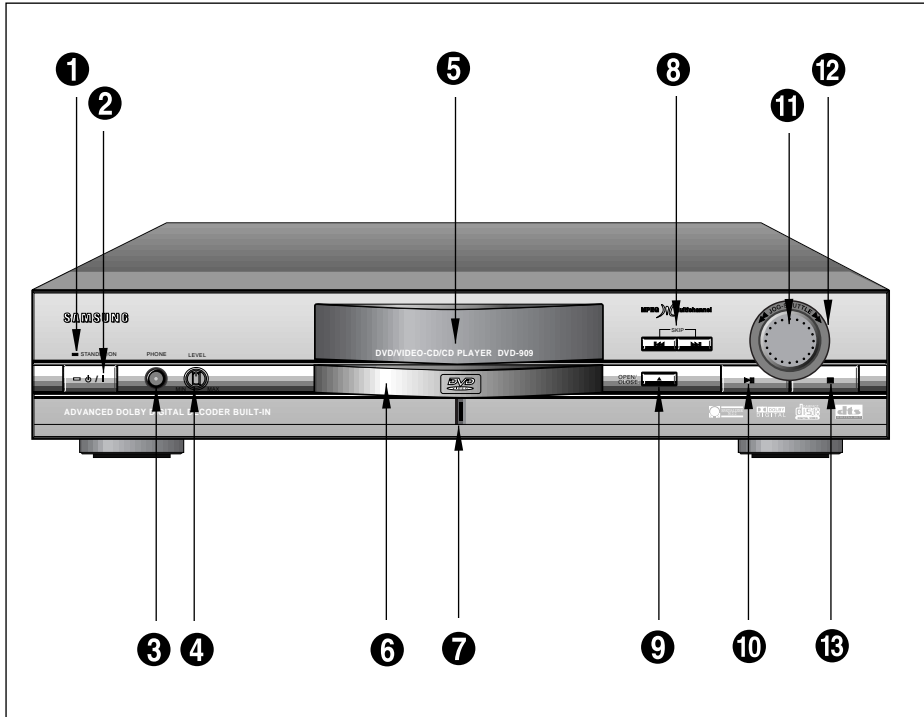

- ❶ STANDBY LAMP**
 - When the unit is first plugged in, the indicator lights. When power is pressed on, the lamp goes out.
- ❷ POWER ON/OFF**
 - Use to turn your player on and off (standby).
- ❸ HEADPHONES JACK**
 - You can attach headphones here for private listening.
- ❹ HEADPHONES VOLUME**
 - Use to adjust headphones volume level.
- ❺ DISPLAY** (See below)
 - Operation indicators are displayed here.
- ❻ DISC TRAY**
 - Press OPEN/CLOSE to open and close the disc tray.
- ❼ GREEN LAMP**
- ❽ SKIP/SEARCH**
 - Use to skip or search a scene or music.
- ❾ OPEN/CLOSE**
 - Press to open and close the disc tray.
- ❿ PLAY/PAUSE**
 - Begin or pause disc play.
- ⓫ JOG DIAL**
 - Operates frame by frame playback. In CD mode, performs track search.
- ⓬ SHUTTLE DIAL**
 - Performs fast or slow motion playback.
- ⓭ STOP**
 - Stops disc play.

Front Display

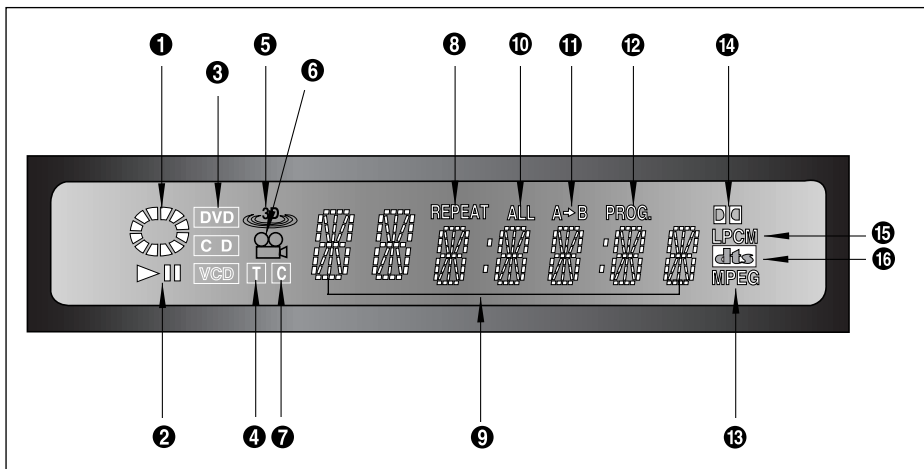

- ❶ DISC OPERATION ROTARY INDICATOR**
- ❷ OPERATION INDICATOR**
- ❸ DISC TYPE INDICATOR**
- ❹ TRACK INDICATOR**
- ❺ 3D SOUND INDICATOR**
- ❻ ANGLE INDICATOR**
- ❼ CHAPTER INDICATOR**
- ❽ REPEAT INDICATOR**
- ❾ CHAPTER, TITLE, TRACK & MESSAGE INDICATOR**
- ❿ ALL REPEAT INDICATOR**
- ⓫ A-B REPEAT INDICATOR**
- ⓬ PROGRAM PLAY INDICATOR**
- ⓭ MPEG INDICATOR**
- ⓮ DOLBY DIGITAL INDICATOR**
- ⓯ LINEAR PCM INDICATOR**
- ⓰ DTS INDICATOR**

Description-Front Panel DVD-709

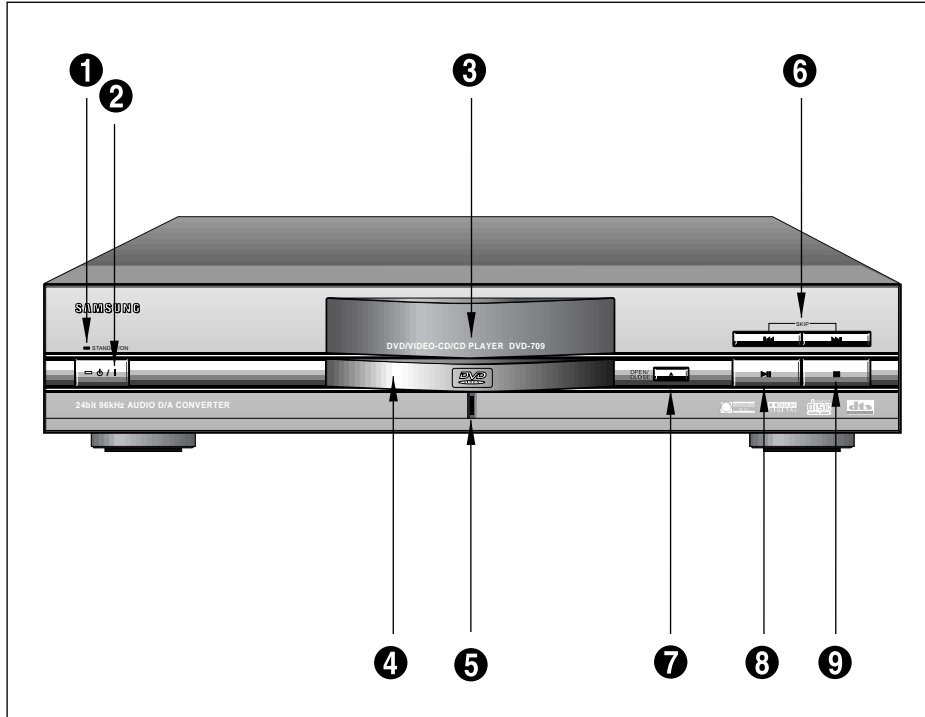

Front Panel Controls

- 1 STANDBY LAMP**
 - When the unit is first plugged in, the indicator lights. When power is pressed on, the lamp goes out.
- 2 POWER ON/OFF**
 - Use to turn your player on and off (standby).
- 3 DISPLAY (See below)**
 - Operation indicators are displayed here.
- 4 DISC TRAY**
 - Press OPEN/CLOSE to open and close the disc tray.
- 5 GREEN LAMP**
- 6 SKIP/SEARCH**
 - Use to skip or search a scene or music.
- 7 OPEN/CLOSE**
 - Press to open and close the disc tray.
- 8 PLAY/PAUSE**
 - Begin or pause disc play.
- 9 STOP**
 - Stops disc play.

Front Display

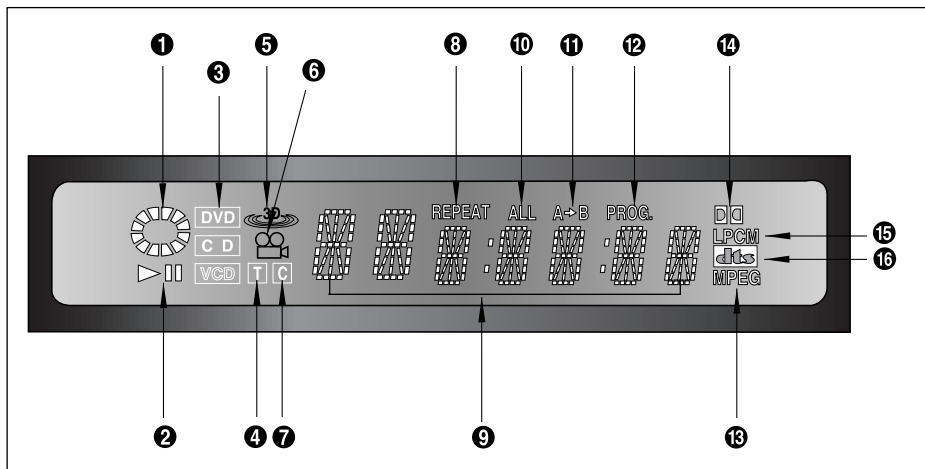

- 1 DISC OPERATION ROTARY INDICATOR**
- 2 OPERATION INDICATOR**
- 3 DISC TYPE INDICATOR**
- 4 TRACK INDICATOR**
- 5 3D SOUND INDICATOR**
- 6 ANGLE INDICATOR**
- 7 CHAPTER INDICATOR**
- 8 REPEAT INDICATOR**
- 9 CHAPTER, TITLE, TRACK & MESSAGE INDICATOR**
- 10 ALL REPEAT INDICATOR**
- 11 A-B REPEAT INDICATOR**
- 12 PROGRAM PLAY INDICATOR**
- 13 MPEG INDICATOR**
- 14 DOLBY DIGITAL INDICATOR**
- 15 LINEAR PCM INDICATOR**
- 16 DTS INDICATOR**

Description-Rear Panel **DVD-909**

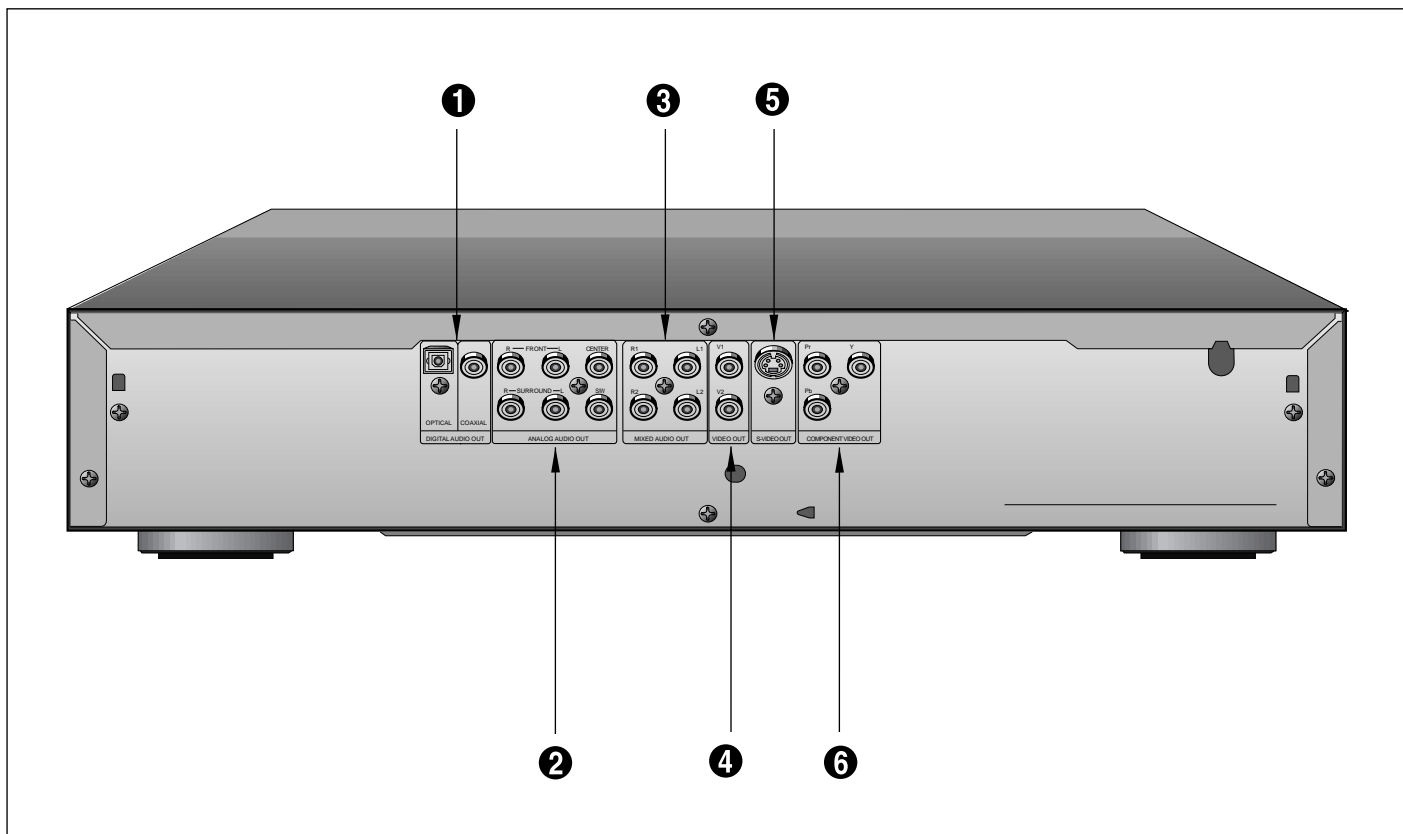

Rear Panel

❶ DIGITAL AUDIO OUT JACK

- Use either an optical or coaxial digital cable to connect to a compatible Dolby Digital receiver. Use to connect to an A/V Amplifier that contains a Dolby Digital decoder or DTS decoder.

❷ 5.1CH ANALOG AUDIO OUT JACKS

- Connect to an amplifier with 5.1ch analog input jacks.

❸ MIXED AUDIO OUT JACKS

- Connect to the Audio input jacks of your television, audio/video receiver, or VCR.

❹ VIDEO OUT JACKS

- Use a video cable to connect one of these jacks to the Video input on your television.

❺ S-VIDEO OUT JACK

- Use the S-Video cable to connect this jack to the S-Video jack on your television for a higher quality picture.

❻ COMPONENT VIDEO OUT JACKS

- Use these jacks if you have a TV with Component Video in jacks. These jacks provide Pr, Pb and Y video. Along with S-Video, Component Video provides the best picture quality.

Description-Rear Panel **DVD-709**

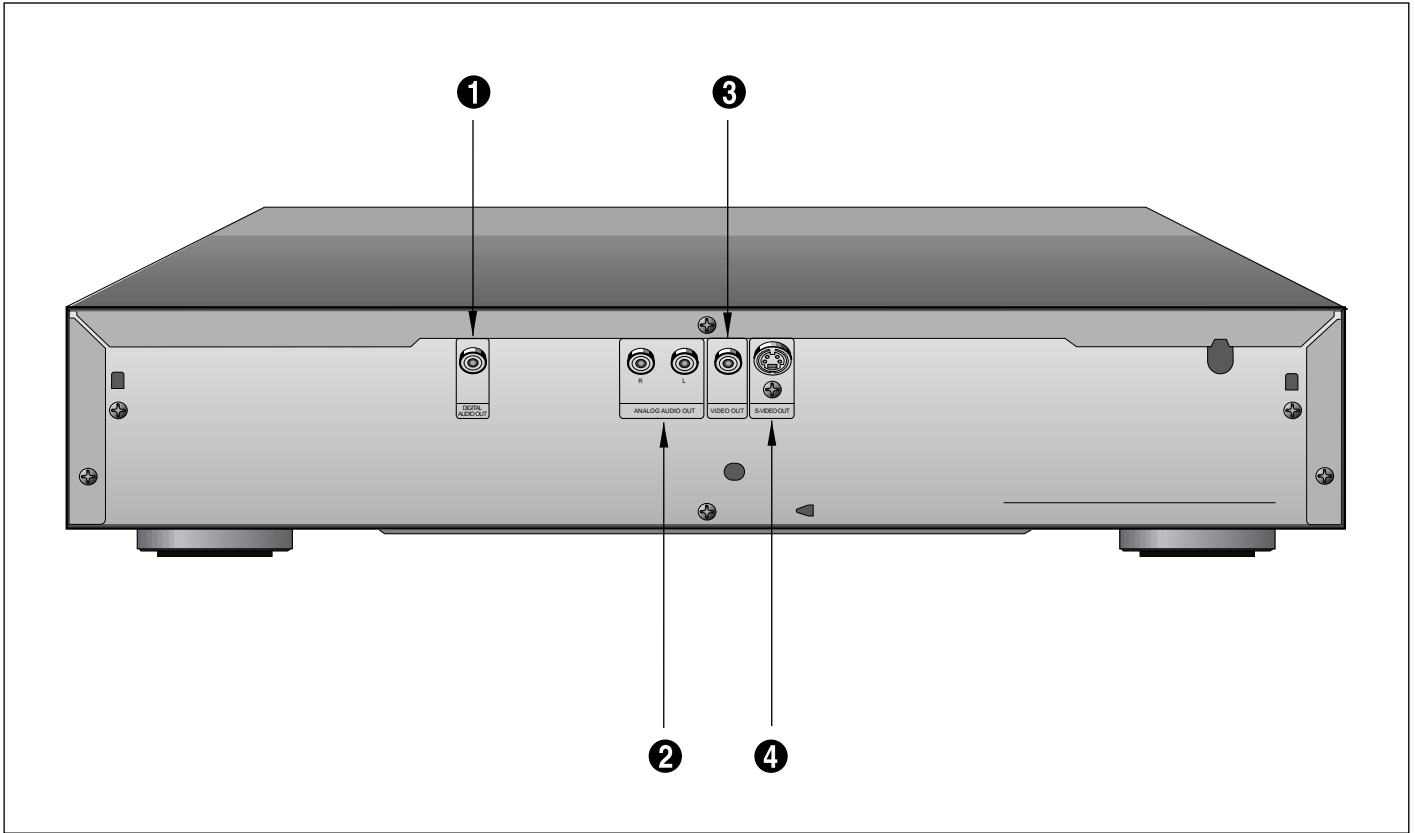

Rear Panel

1 DIGITAL AUDIO OUT JACK

- Use a coaxial digital cable to connect to an A/V Amplifier that contains a Dolby Digital decoder or DTS decoder.

2 ANALOG AUDIO OUT JACKS

- Connect to the Audio input jacks of your television, audio/video receiver, or VCR.

3 VIDEO OUT JACK

- Use a video cable to connect this jack to the Video input on your television.

4 S-VIDEO OUT JACK

- Use the S-Video cable to connect this jack to the S-Video jack on your television for a higher quality picture.

A Tour of the Remote Control

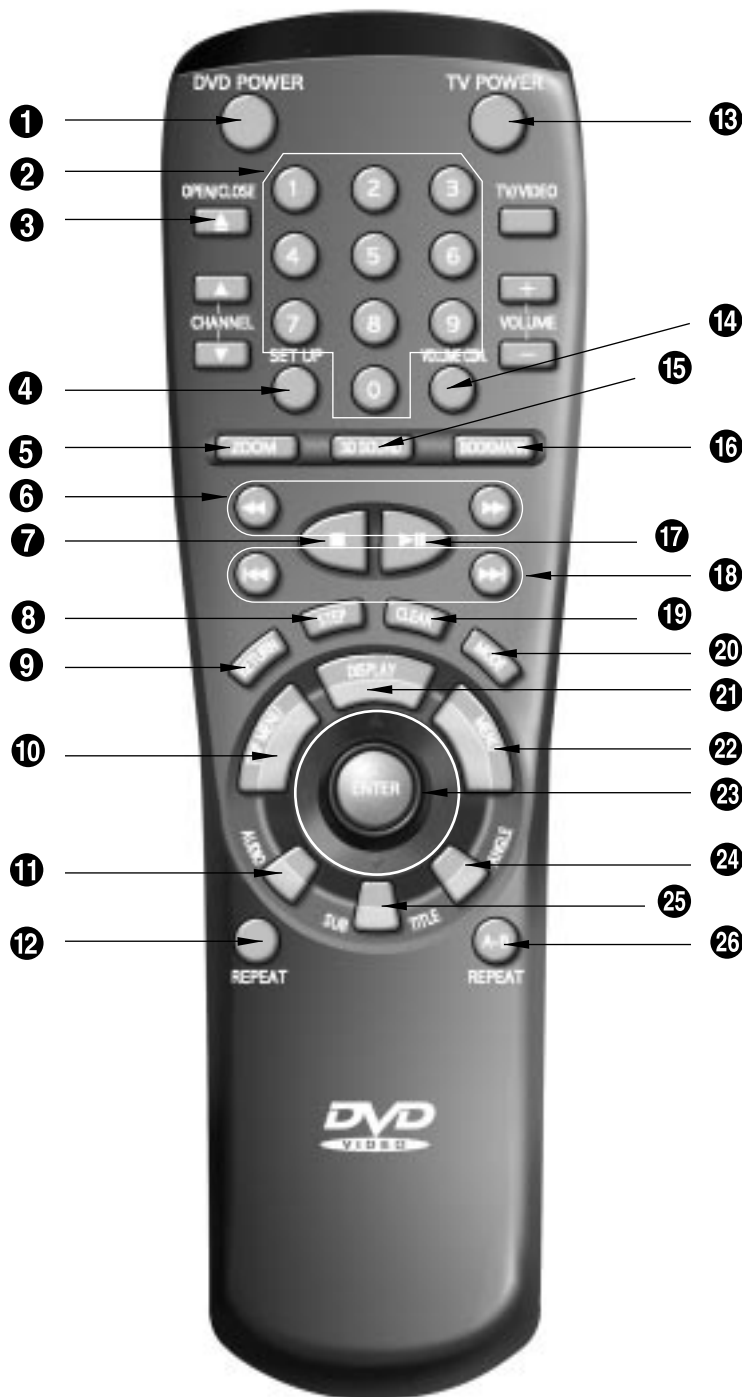

DVD Function Buttons

- ❶ **DVD POWER Button**
- ❷ **NUMBER Buttons**
- ❸ **OPEN/CLOSE Button**
- ❹ **SETUP Button**
 - Brings up the DVD player's Setup menu.
- ❺ **ZOOM Button**
- ❻ **SEARCH Buttons**
 - Allows you to search forward/backward through a disc.
- ❼ **STOP Button**
- ❽ **STEP Button**
 - Advances playback one frame at a time.
- ❾ **RETURN Button**
 - Returns to a previous menu.
- ❿ **TOP MENU Button**
 - Accesses a music or video display directly.
- ⓫ **AUDIO Button**
 - Use this button to access various audio functions on a disc.
- ⓬ **REPEAT Button**
 - Allows you to repeat play a title, chapter, track, or disc.
- ⓭ **TV POWER Button**
 - Use to set the remote to control a compatible TV.
- ⓮ **VOLUME CON. Button**
 - To control the master volume of the player.
- ⓯ **3D SOUND Button**
- ⓰ **BOOKMARK Button**
- ⓱ **PLAY/PAUSE Button**
 - Begin/Pause disc play.
- ⓲ **SKIP Buttons**
 - Use to skip the title, chapter, or track.
- ⓳ **CLEAR Button**
 - Use to remove menus or status displays from the screen.
- ⓴ **MODE Button**
 - Allows you to program a specific order.
- ⓵ **DISPLAY Button**
 - Displays the current disc mode.
- ⓶ **MENU Button**
 - Brings up the Disc menu.
- ⓷ **ENTER/DIRECTION Button (UP/DOWN or LEFT/RIGHT Button)**
 - This button functions as a toggle switch.
- ⓸ **ANGLE Button**
 - Use to access various camera angles on a DVD.
- ⓹ **SUBTITLE Button**
- ⓺ **A-B REPEAT Button**
 - Use to mark a segment to repeat between A and B.

A Tour of the Remote Control (Cont d)



TV Function Buttons

- ❶ TV POWER Button
- ❷ TV/VIDEO Selection Button
- ❸ CHANNEL UP/DOWN Buttons
- ❹ VOLUME UP/DOWN Buttons

Install Batteries in the Remote

1. Open the battery cover on the back of the remote.
2. Insert two AA batteries. Make sure that the polarities (+ and -) are aligned correctly.
3. Replace the battery cover.

If remote doesn't operate properly:

- Check the polarity + - of the batteries (Dry-Cell)
- Check if the batteries are drained.
- Check if remote sensor is blocked by obstacles.
- Check if there is any fluorescent lighting nearby.

To Connect Headphones (not included) (DVD-909 only)

Connect headphones with a standard stereo plug to the headphone jack (M6).

- Before connecting, set headphone volume at minimum. Then adjust to a suitable volume.

NOTE This  icon indicates an invalid button press.

Choosing a Connection **DVD-909**

The following show examples of connections commonly used to connect the DVD player with a TV and other components.

Before Connecting the DVD Player

- Always turn off the DVD player, TV, and other components before you connect or disconnect any cables.
- Refer to owner's manual of the components you are connecting for more information on those particular components.

Connecting to a TV (For Video)

- **Method 1**
DVD Player + TV with Video Input Jack
- **Method 2**
DVD Player + TV with S-Video Input Jack
- **Method 3**
DVD Player + TV with Component Video Jacks

Connecting to a TV

TV (Normal, Widescreen, Projection, etc..)

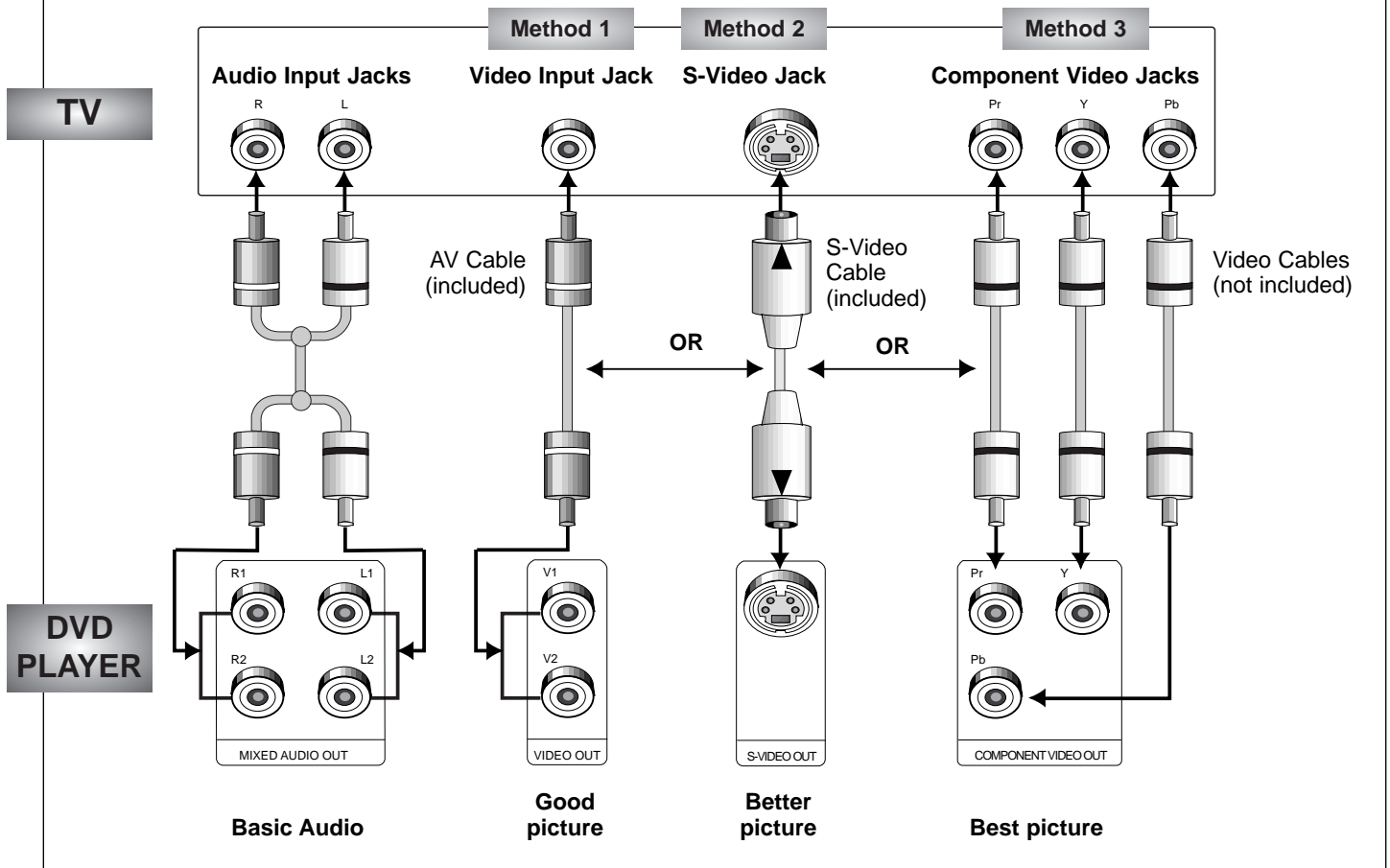

Choosing a Connection (Cont'd)

Connecting to an Audio System

Method 1

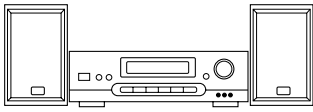

2ch Amplifier
Audio Input Jacks

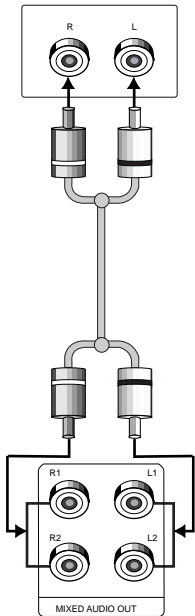

Mixed Audio Out

Method 2

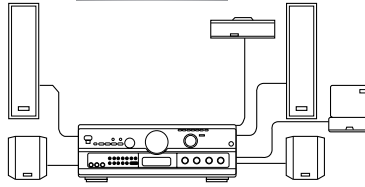

5.1ch Analog Amplifier
Audio Input Jacks

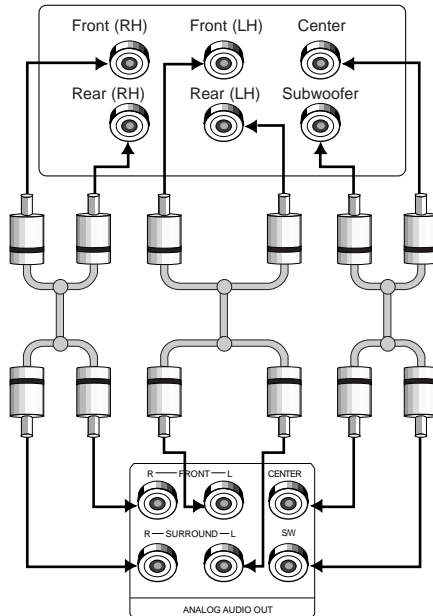

Analog Audio Out

Method 3

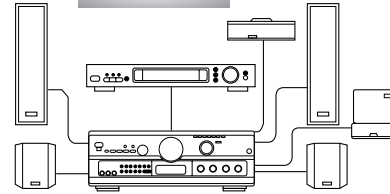

Dolby Digital Decoder
Digital Audio Input Jacks

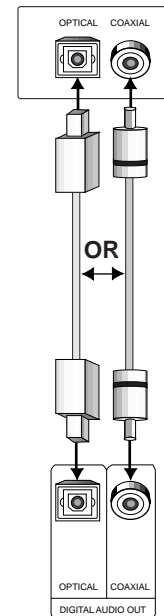

Digital Audio Out

AUDIO SYSTEM

DVD PLAYER

CONNECTIONS

Rear Panel

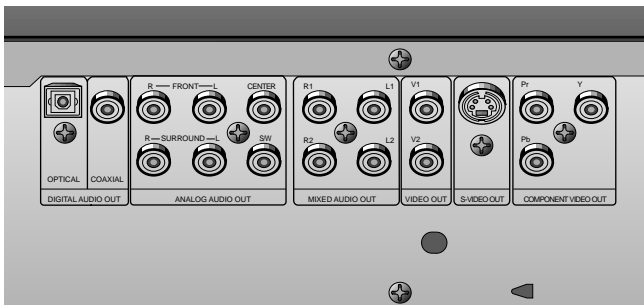

Connecting to an Audio System

- **Method 1**
DVD Player + 2ch Stereo Amplifier or
Dolby Pro Logic Decoder
- **Method 2**
DVD Player + Amplifier with 5.1ch
Analog Input Jacks
- **Method 3**
DVD Player + Amplifier with Dolby
Digital Decoder/DTS Decoder

Choosing a Connection **DVD-709**

The following show examples of connections commonly used to connect the DVD player with a TV and other components.

Before Connecting the DVD Player

- Always turn off the DVD player, TV, and other components before you connect or disconnect any cables.
- Refer to owner's manual of the additional components you are connecting for more information for those particular components.

Connecting to a TV (For Video)

- **Method 1**
DVD Player + TV with Video Input Jack
- **Method 2**
DVD Player + TV with S-Video Input Jack

Connecting to a TV

TV (Normal, Widescreen, Projection, etc..)

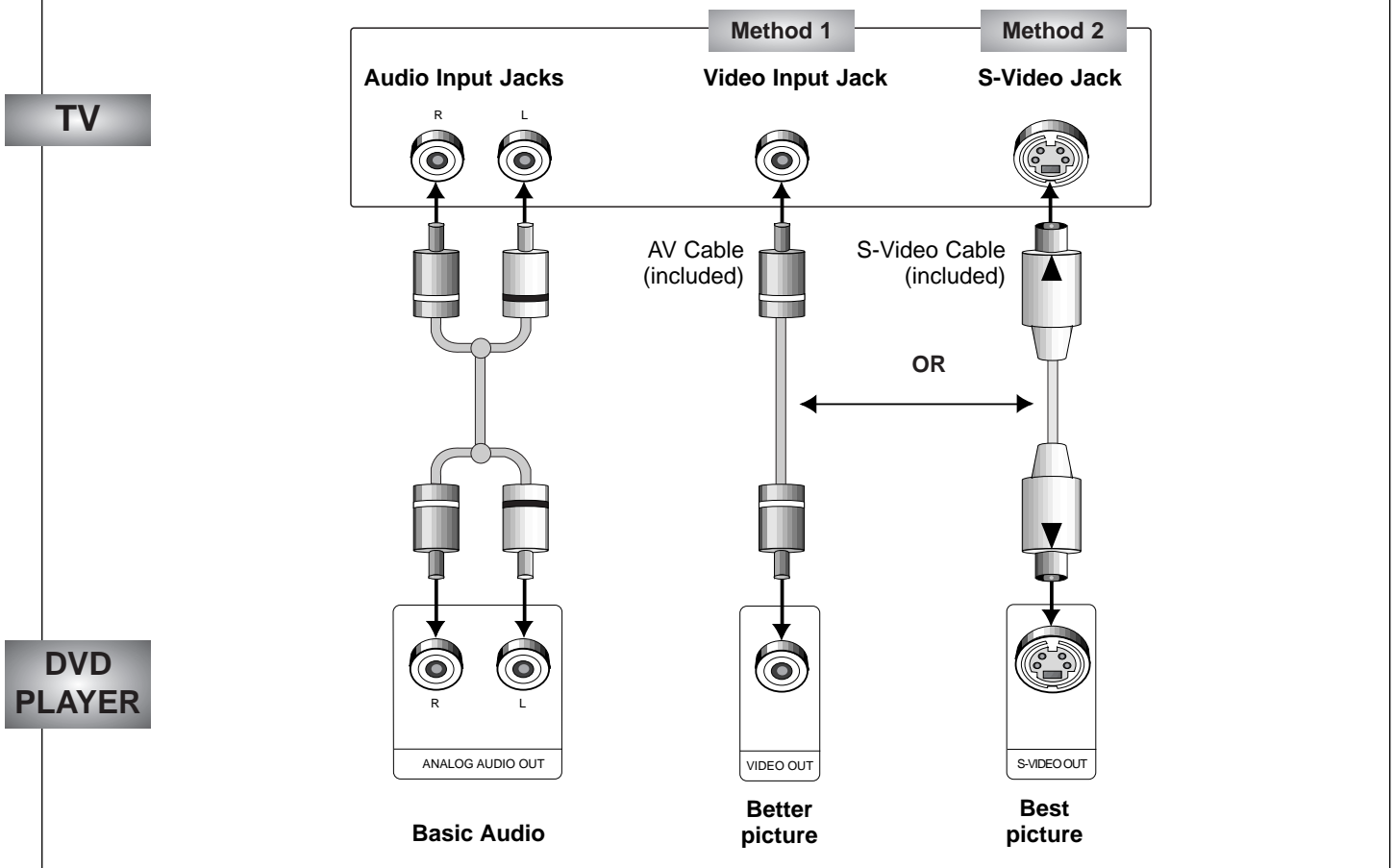

Choosing a Connection (Cont'd)

Connecting to an Audio System

Method 1

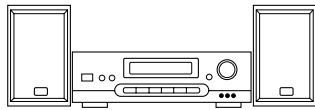

2ch Amplifier

Audio Input Jacks

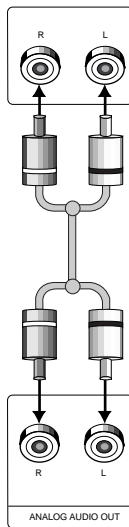

Analog Audio Out

Method 2

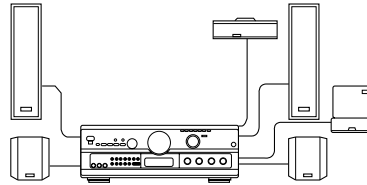

Dolby Digital Decoder

Digital Audio Input Jack

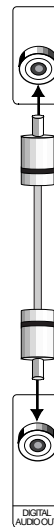

Digital Audio Out

AUDIO SYSTEM

DVD PLAYER

CONNECTIONS

Rear Panel

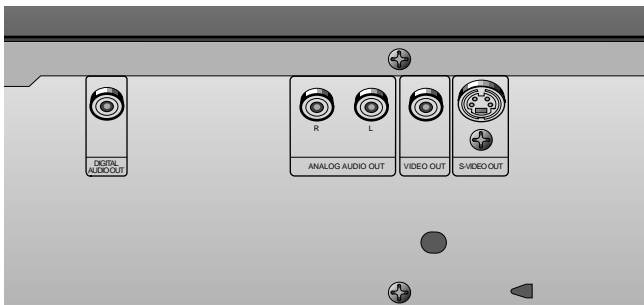

Connecting to an Audio System

- **Method 1**
DVD Player + 2ch Stereo Amplifier or Dolby Pro Logic Decoder
- **Method 2**
DVD Player + Amplifier with Dolby Digital Decoder/DTS Decoder

Playing a Disc

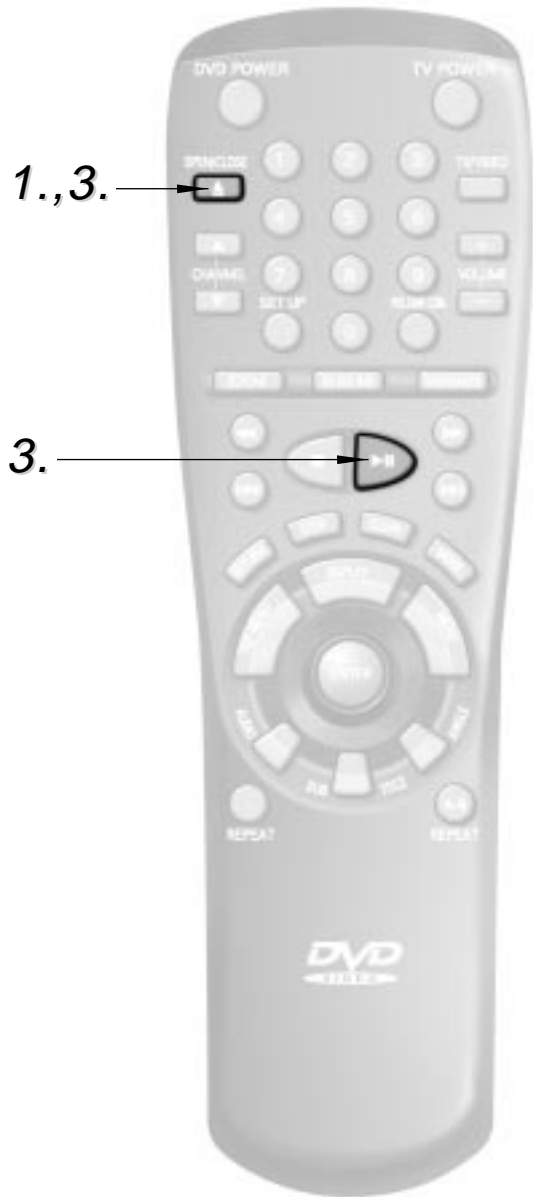

Before Playback

- Turn on a TV and press the TV/VIDEO button to select video mode.
- Turn on your Audio System to select AUX, CD or DVD.
- Refer to your AUDIO Owner's Manual.

After plugging in the player, the first time you press the DVD POWER button, this screen comes up :



If you want to select the language, press a NUMBER button. (This screen will only appear the very first time you plug in the player.)

Playback

1. Press the OPEN/CLOSE button.
 - The STANDBY indicator light goes out and the tray opens.
2. Place a disc gently into the tray with the disc's label facing up.
3. Press the PLAY/PAUSE button or OPEN/CLOSE button to close the disc tray.

Playing a Disc (Cont d)

Several options are available during DVD playback.

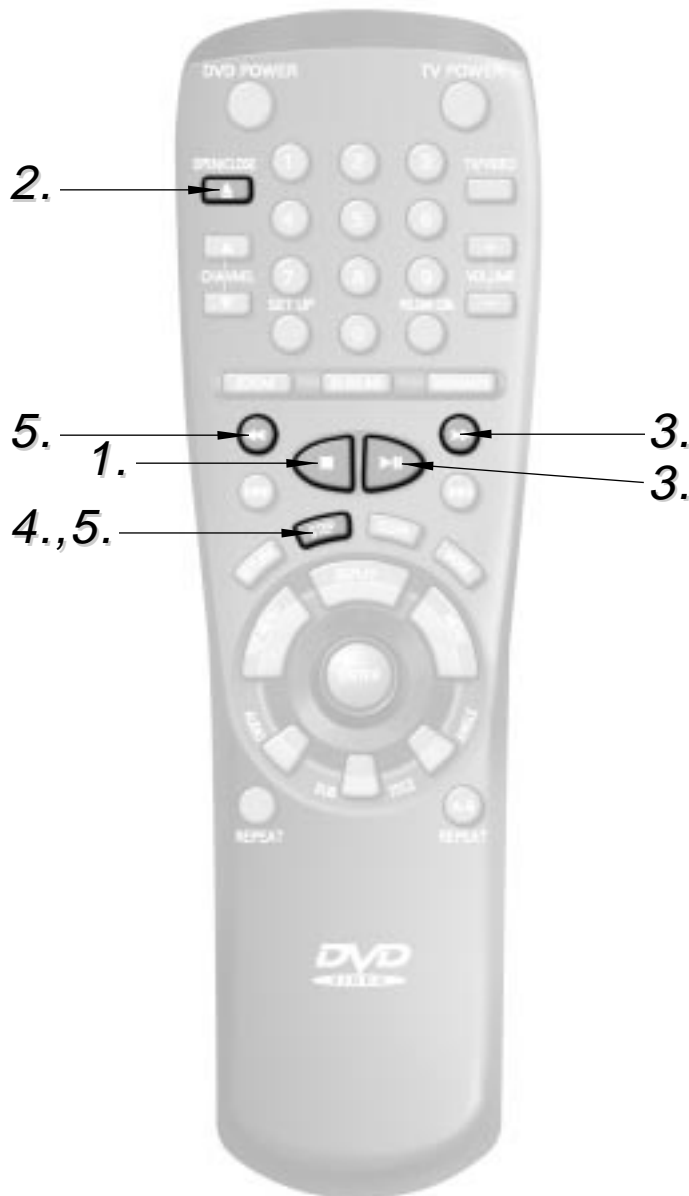

1 Stopping Playback

- Press the STOP button in playback.

2 Removing Disc

- Press the OPEN/CLOSE button.

3 Pausing Playback

- Press the PLAY/PAUSE or STEP button on the remote during playback.
 - Screen stops, no sound.
 - To resume again, press PLAY/PAUSE button once again.

4 Step Motion Playback (Except CD)

- Press the STEP button on the remote or turn JOG dial (DVD-909 only) on the front of the DVD player during playback.
 - Each time the button is pressed, a new frame will appear.
 - No sound is heard during STEP mode.
 - Press PLAY/PAUSE to resume normal playback. (You can only perform step motion playback in the forward direction.)

5 Slow Motion Playback (Except CD)

- Press the FWD or REV SEARCH button on the remote or turn the SHUTTLE dial (DVD-909 only) on the front of the DVD player during PAUSE or STEP mode.
 - By pressing or shuttling, you can select slow motion playback for 1/2, 1/4 or 1/8 of normal speed.
 - No sound is heard during slow mode.
 - Press PLAY/PAUSE to resume normal playback.
 - When playing a VCD, the reverse slow motion playback will not work.

RESUME function

When you stop disc play, the player remembers where you stopped, so when you press PLAY again, it will pick up where you left off (unless the disc is removed, the STOP button is pressed twice or the player is unplugged.).

NOTE

- If the player is left for 5 minutes in pause mode, it will stop.
- The power is automatically turned off after approximately 30 minutes have elapsed in the stop mode (auto power-off feature).
- If the player is left in the stop mode for more than one minute without any user interaction, a screensaver will be activated, and the TV screen will fade in and fade out repeatedly. Press PLAY button to resume normal play.

Searching & Skipping through a Chapter or Track

During playback, you can search quickly through a chapter or track or use the skip function to jump to the next selection.

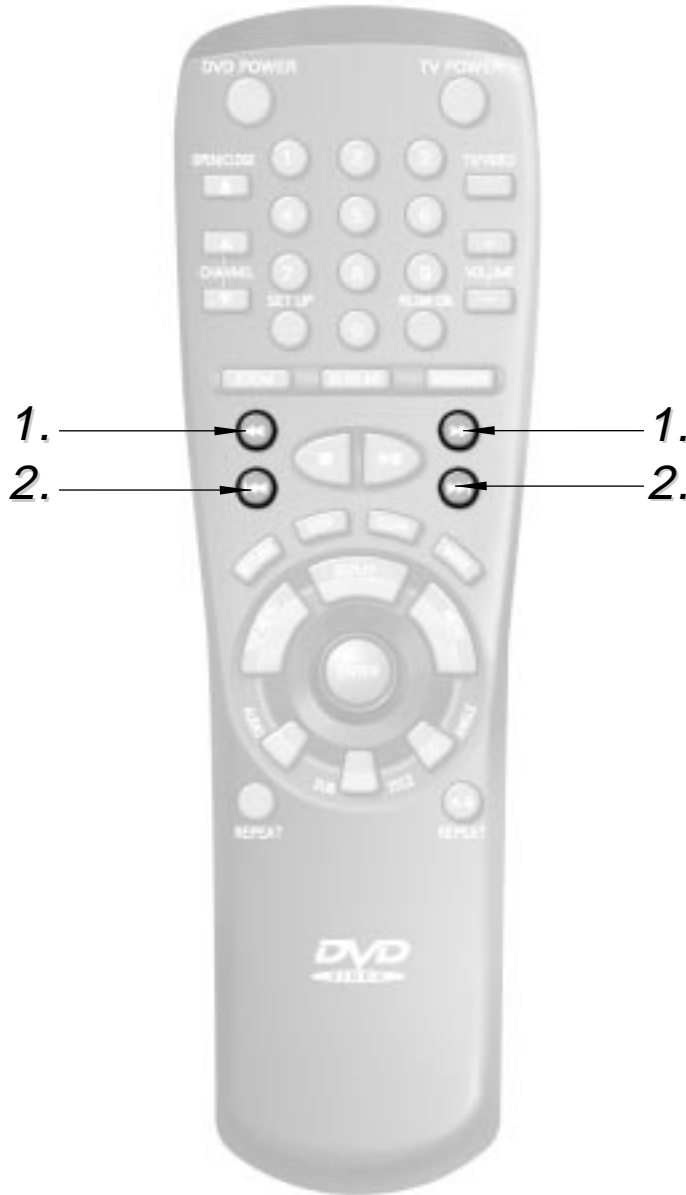

Searching through a Chapter or Track

1. Press the FWD or REV SEARCH button on the remote or turn the SHUTTLE dial (DVD-909 only) on the front of the DVD player during PLAY mode.

- Press the REVERSE or FORWARD SEARCH button on the remote and press again to search at a faster speed (2X/8X/16X/32X/normal speed, in order) on DVD.
- Press the REVERSE or FORWARD SEARCH button on the remote and press again to search at a faster speed (4X/8X/normal speed in order) on VCD and CD.
- To return to normal speed playback, press the PLAY/PAUSE button.

Skipping Tracks

2. Press the NEXT SKIP or BACK SKIP button during playback.

- When playing a DVD, if you press the NEXT SKIP button, it moves to next chapter. If you press the BACK SKIP button, it moves to the beginning of the chapter. One more press makes it move to the beginning of the previous chapter.
- When playing a VCD 2.0 in MENU OFF mode, a VCD 1.1 or a CD, if you press NEXT SKIP button, it moves to next track. If you press BACK SKIP button, it moves to the beginning of the track. One more press makes it move to the beginning of the previous track.
- If a track exceeds 15 minutes when playing a VCD and you press NEXT SKIP button, it moves forward 5 minutes. If you press BACK SKIP button, it moves backward 5 minutes.
- When playing a VCD 2.0 in the MENU MODE or Track View function, if you press NEXT SKIP button, it moves to the next MENU or the next Track View display. If you press BACK SKIP button, it moves to the previous MENU or the previous Track View display. (Refer to page 25.)

NOTE

- While in search (8X/16X/32X) on DVD or high-speed playback on VCD, no sound will be heard.
- Though 2X SCAN AUDIO is ON in SETUP MENU, no sound will be heard on discs which are recorded with LPCM, DTS or MPEG-2.
- Depending on the disc, audio may not be heard when a disc is in 2X playback mode.

Using the Display Function

If you want to display the title, chapter, time, audio and subtitle information on a DVD, press the DISPLAY button. If you want to display the track and time information on a VCD or CD, press the DISPLAY button.

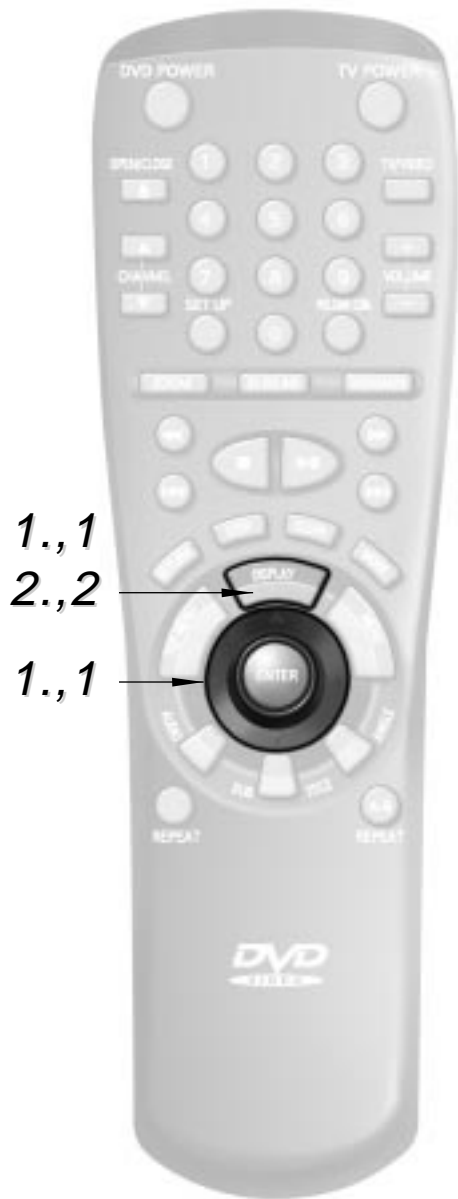

1., 1

2., 2

1., 1

When Playing a DVD

1. During playback, press the DISPLAY button on the remote.

- Current title, chapter number and elapsed time will be displayed.

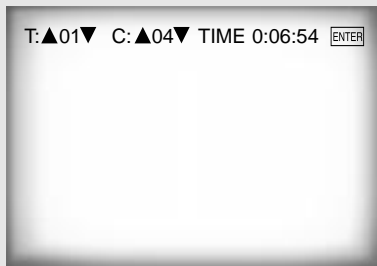

- Use the LEFT/RIGHT button to select a title or a chapter number. Use the UP/DOWN button or Number buttons to enter a different title or chapter number, then press the ENTER button.
- To enter the time from which you want to start, use the LEFT/RIGHT button to select, then use the Number buttons to enter the time. Then press the ENTER button.

2. Press the DISPLAY button on the remote twice.

- Current audio and subtitle information will appear.

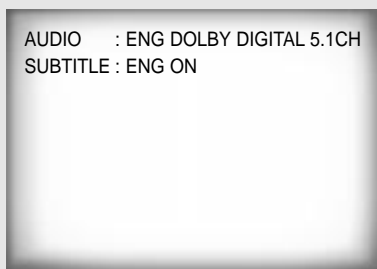

- To make the screen disappear, press the DISPLAY button again.

When Playing a CD/VCD

1. During playback, press the DISPLAY button on the remote.

- Current track number and elapsed time will be displayed.

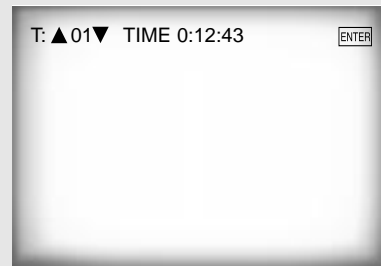

- Use the LEFT/RIGHT button to select a track. Use the UP/DOWN button or Number buttons to enter a different track number and then press the ENTER button.
- To enter the time from which you want to start, use the LEFT/RIGHT button to select, then use the Number buttons to enter the time. Then press the ENTER button.

2. Press the DISPLAY button on the remote twice.

- Elapsed time and remain time will appear.

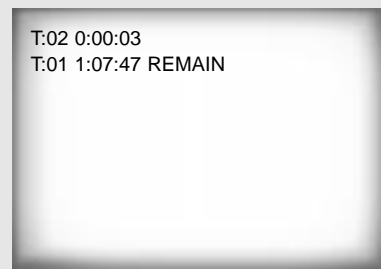

- To make the screen disappear, press the DISPLAY button again.

NOTE

What is a Chapter?
Each Title on a DVD can be divided into chapters (similar to tracks on an audio CD).

What is a Title?

A DVD may contain several different titles. : for example, if a disc contains four different movies, each might be considered a title.

Repeat Play

Repeat play allows you to repeat a track, title, or the entire disc.



1., 1
2., 2
3., 3
4., 4

When playing a DVD

1. Press the REPEAT button once to display the current status.
2. Press the REPEAT button twice to repeat the chapter currently playing.



3. Press the REPEAT button a third time to repeat the title currently playing.



4. Press the REPEAT button again to turn off the repeat feature.



When playing a CD/VCD

1. Press the REPEAT button once to display the current status.
2. Press the REPEAT button twice to repeat the current track.

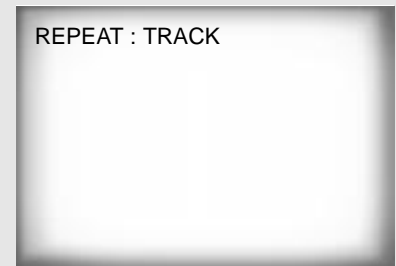

3. Press the REPEAT button a third time to repeat all tracks.



4. Press the REPEAT button again to turn off the repeat feature.



NOTE

- DVD repeats playback by chapter or title, CD and VCD repeat playback by disc or track.
- Depending on the disc, the Repeat function may not work.
- When in VCD 2.0 mode (MENU ON mode), this function does not work.

Using the A-B Repeat Function

The A-B Repeat function lets you mark a segment to repeat between the beginning (A) and the end (B) of the segment you want to review.

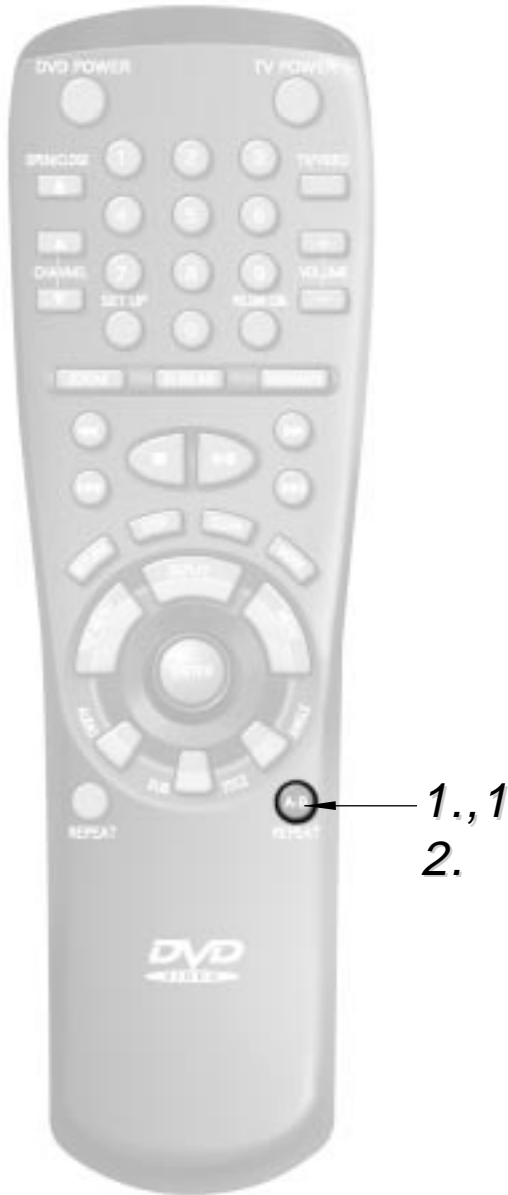

1., 1
2.

To set up A-B Repeat

1. Press the A-B REPEAT button at the beginning (A) of the segment you want to review.

REPEAT : A -

2. Press the A-B REPEAT button again at the end (B) of the segment you want to review. The segment will begin repeating.

REPEAT : A - B

To clear A-B Repeat

1. Press the A-B REPEAT button.

REPEAT : OFF

NOTE

- The A-B Repeat function works on the same title or track.
- If the title or track is completed before marking the end (B), the end of title or track becomes B automatically.
- Depending on the disc, the A-B REPEAT function may not work.
- When in VCD 2.0 mode (MENU ON mode), this function does not work.

Program Playback in a Specific Order

Program playback lets you set up a specific order for playback of titles, chapters or tracks on a disc only. This function works in stop mode only.

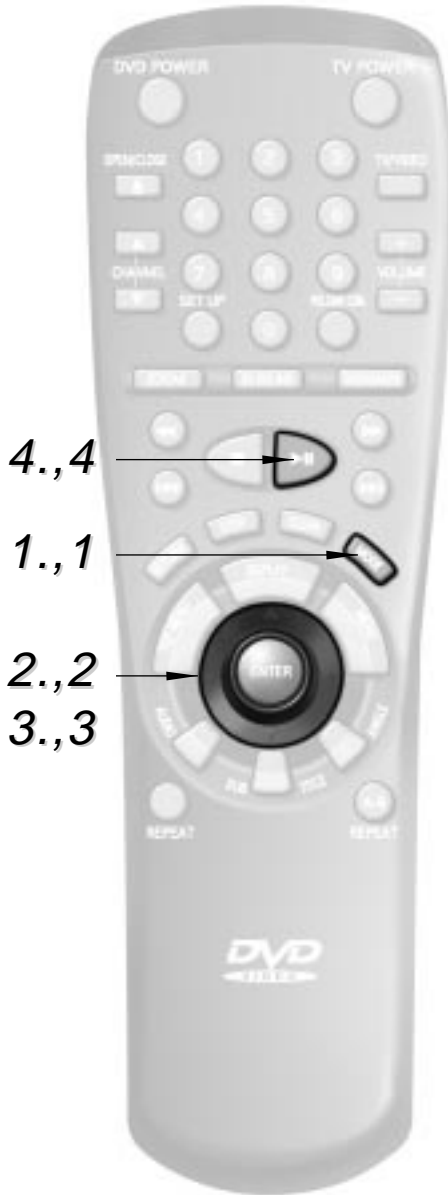

Program DVD

e.g To program chapters 5 and 7 in order.

1. In stop mode, press the **MODE** button.

TITLE				CHAPTER			
01	02	03	04	--	--	--	--
05	06	07	08	--	--	--	--
09	10	11	12	--	--	--	--
13	14	15	16	--	--	--	--

2. Use the LEFT/RIGHT button to select **CHAPTER**. Press the **ENTER** button.

3. Use the LEFT/RIGHT or UP/DOWN button to select 05 and press **ENTER**. Then select 07 and press **ENTER** button.

4. Press the **PLAY/PAUSE** button. The disc will be played back in programmed order.

Program VCD or CD

e.g To program tracks 5 and 7 in order.

1. In stop mode, press the **MODE** button.

2. Use the LEFT/RIGHT button to select **PROGRAM**. Press the **ENTER** button.

TRACK				PROGRAM ORDER			
01	02	03	04	--	--	--	--
05	06	07	08	--	--	--	--
09	10	11	12	--	--	--	--
13	14	15	16	--	--	--	--

CLEAR LAST TRACK
CLEAR ALL TRACKS

PRESS **PLAY** TO START

3. Use the LEFT/RIGHT or UP/DOWN button to select 05 and press **ENTER**. Then select 07 and press the **ENTER** button.

4. Press the **PLAY/PAUSE** button. The disc will be played back in programmed order.

e.g To start **RANDOM** playback.

- Press the **MODE** button while in stop mode.
- Use the LEFT/RIGHT button to select **RANDOM** and press the **ENTER** button.

- The disc will be played back in random order.

When you make a wrong selection during programming

- Use the UP/DOWN button to select **CLEAR LAST TRACK** (or **CHAPTER**, or **TITLE**).
- Press the **ENTER** button to delete the last track (or chapter, or title) in the program order.

When you want to delete the entire program

- Use the UP/DOWN button to select **CLEAR ALL TRACKS** (or **CHAPTERS**, or **TITLES**).
- Press the **ENTER** button to delete all tracks, chapters or titles in the program order. All programmed tracks, chapters or titles are also deleted when the disc is removed or the DVD player is turned off.

NOTE

- Depending on the disc, the Program Playback function may not work.
- To resume normal playback, press the **CLEAR** button.

Using the Disc View Function

The desired music or video display can be accessed directly without using the menu function.

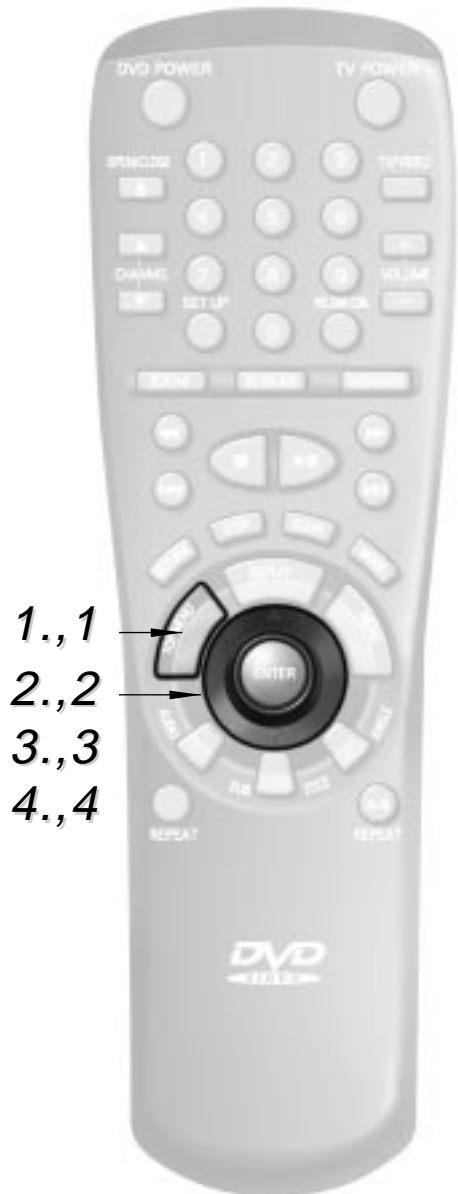

Track View (VCD)

Displays the beginning view of each track and the track number.

1. Press the TOP MENU button during playback.

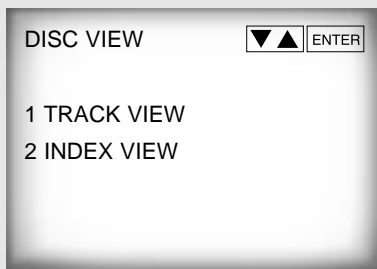

2. Press the UP/DOWN button to select TRACK VIEW. Press the ENTER button.

3. Select the desired view by pressing the UP/DOWN or LEFT/RIGHT buttons.

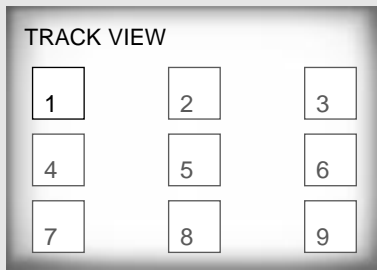

(An example of a Track View)

4. Press the ENTER button.

Index View (VCD)

Displays the equally divided 9 views of the current playing track.

1. Press the TOP MENU button during playback.
2. Press UP/DOWN button to select INDEX VIEW. Press the ENTER button.
3. Select the desired view by pressing UP/DOWN or LEFT/RIGHT buttons.

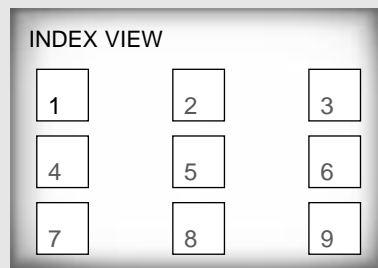

4. Press the ENTER button.

When you press the TOP MENU button during DVD playback

The disc's TITLE MENU function will come up. A disc must have at least two titles for the TITLE MENU function to work.

When you press the TOP MENU button during CD playback

The unit enters the INTRO SCAN mode. INTRO SCAN lets you listen to the beginning of each track for about 10 seconds.

NOTE

- When in VCD 1.1 & 2.0 mode (MENU OFF mode), this function works.
- In stop mode on VCD, press the TOP MENU button and the TRACK VIEW will be displayed directly.

Selecting Audio

You can select a desired language quickly and easily with the AUDIO button. If a menu is encoded on the disc, you can also select by using the MENU button.

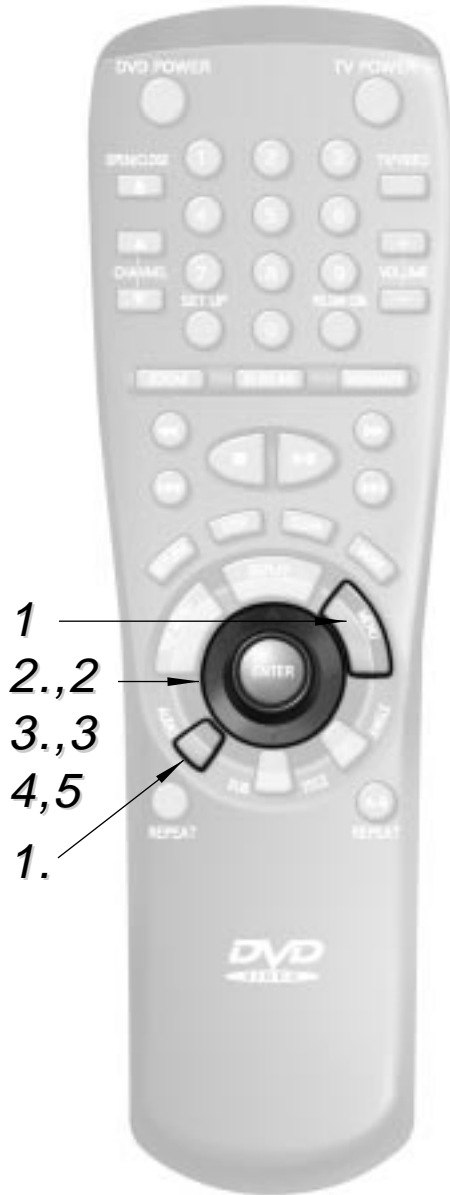

Using the Audio Button

1. Press the AUDIO button.
2. Use the UP/DOWN button to select the desired language on a DVD.

AUDIO: ▲ ENG ▼ DOLBY DIGITAL 5.1CH

- The audio and subtitle languages are represented by abbreviations.

3. Use the UP/DOWN button to select STEREO, R CHANNEL or L CHANNEL. (On VCD/CD)

AUDIO: ▲ STEREO ▼

Using the Menu Button

When playing a DVD

- 1 Press the MENU button.
- 2 Use the UP/DOWN button to select AUDIO information.

1 AUDIO
2 SUBTITLE

(An example of a disc menu)

- 3 Press the ENTER button.
- 4 Use the UP/DOWN button to select 'ENGLISH'.

1 ENGLISH
2 FRANCAIS

(An example of a disc menu)

- 5 Press the ENTER button.

When playing a VCD

In disc version 2.0, the MENU button works as a conversion switch between MENU ON and MENU OFF mode. When playing a VCD 1.1 or CD, the MENU button will not work.

How to have the same audio language come up whenever you play back a DVD.

Refer to "Setting Up the Language Features" on page 33.

NOTE

- This function depends on what languages are encoded on the disc and may not work with all DVDs.
- A DVD disc can contain up to 8 audio languages.

Selecting the Subtitle Language

When a DVD is recorded with subtitles, you can use the Subtitle feature to view the subtitles on-screen. If a menu is encoded on the disc, you can also select by using the MENU button.

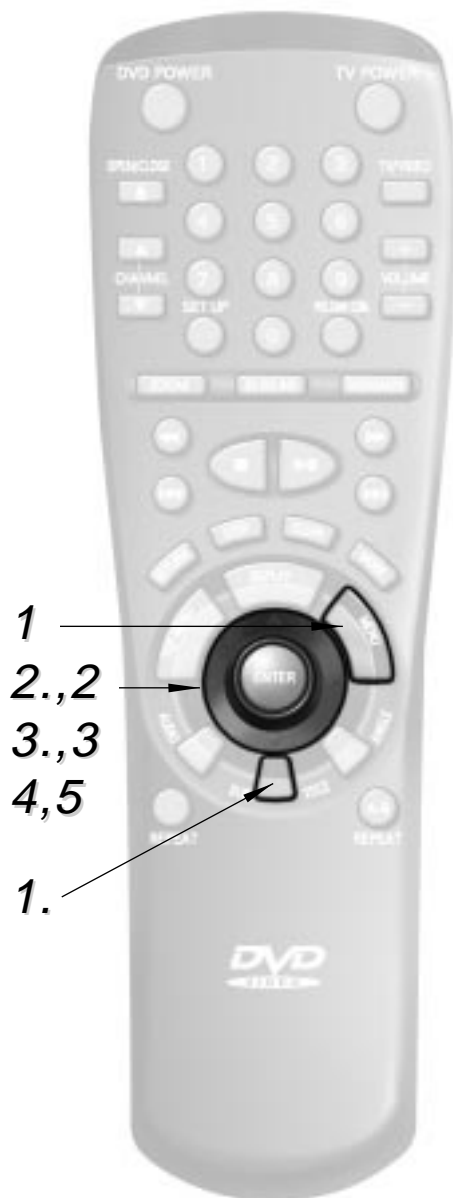

Using the SUBTITLE button

1. Press the SUBTITLE button.
2. Use the UP/DOWN button to select the desired subtitle language.

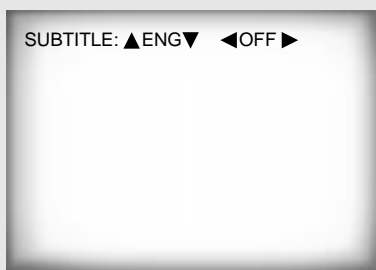

3. Use the LEFT/RIGHT button to determine whether or not the subtitle will be displayed.

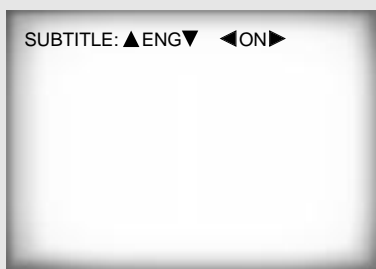

- Initially, the subtitling will not appear on screen.
- The audio and subtitle languages are represented by abbreviations.

Using the MENU button

1. Press the MENU button.
2. Use the UP/DOWN button to select SUBTITLE information.



(An example of a disc menu)

3. Press the ENTER button.
4. Use the UP/DOWN button to select the desired language.



(An example of a disc menu)

5. Press the ENTER button.

When playing a VCD

In disc version 2.0, the MENU button works as a conversion switch between MENU ON and MENU OFF mode. When playing a VCD 1.1 or CD, the MENU button will not work.

How to have the same subtitle language come up whenever you play back a DVD.

Refer to "Setting Up the Language Features" on page 33.

NOTE

- This function depends on what languages are encoded on the disc and may not work with all DVDs.
- A DVD disc can contain up to 32 subtitle languages.

Selecting the Desired Screen Angle

When a DVD contains multiple angles of a particular scene, you can select the Angle function.

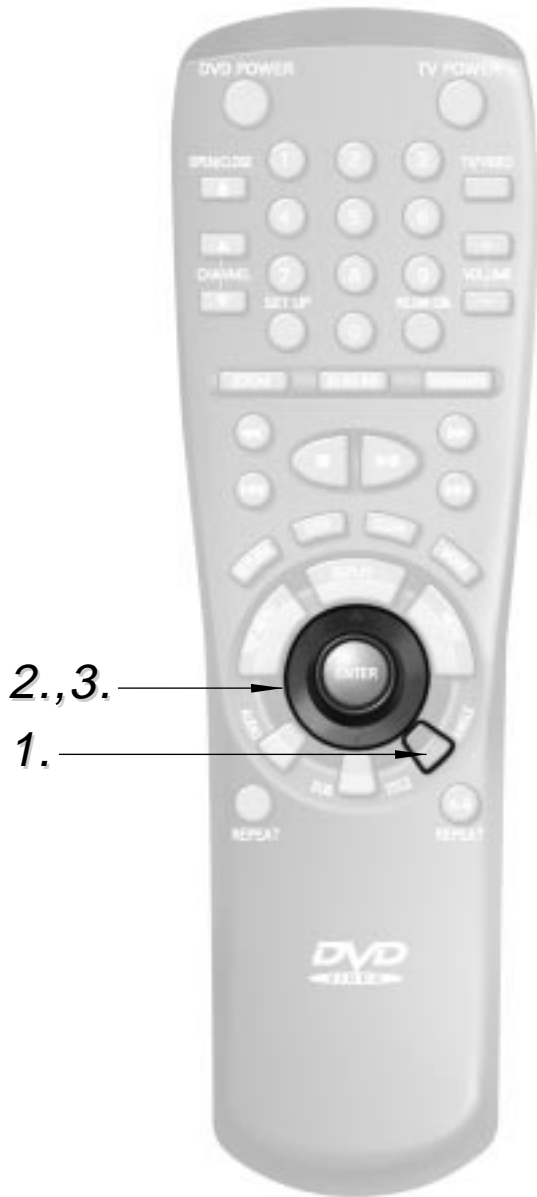

Using the ANGLE button

Check to see if an 'ANGLE ()' mark is present at the upper right hand corner of the screen.

1. When an 'ANGLE' mark is shown, press the ANGLE button.



(Angle information display example)

2. Use the UP/DOWN button to select the desired screen angle. Then press the ENTER button.

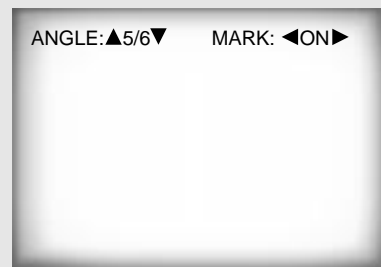

(Angle information display example)

3. Use the LEFT/RIGHT button to determine whether or not the 'ANGLE' mark will be displayed.

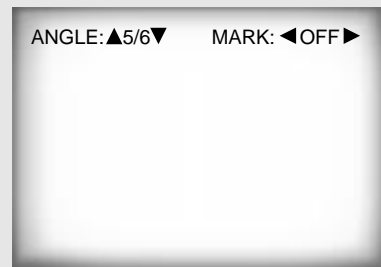

NOTE

- This function is disc-dependent, and may not work with all DVDs.
- This function does not work when a DVD has not been recorded with a multi-camera angle system.

Using the Bookmark Function

The Bookmark function lets you select parts of a DVD or VCD (MENU OFF mode) so that you can quickly find the section at a later time.

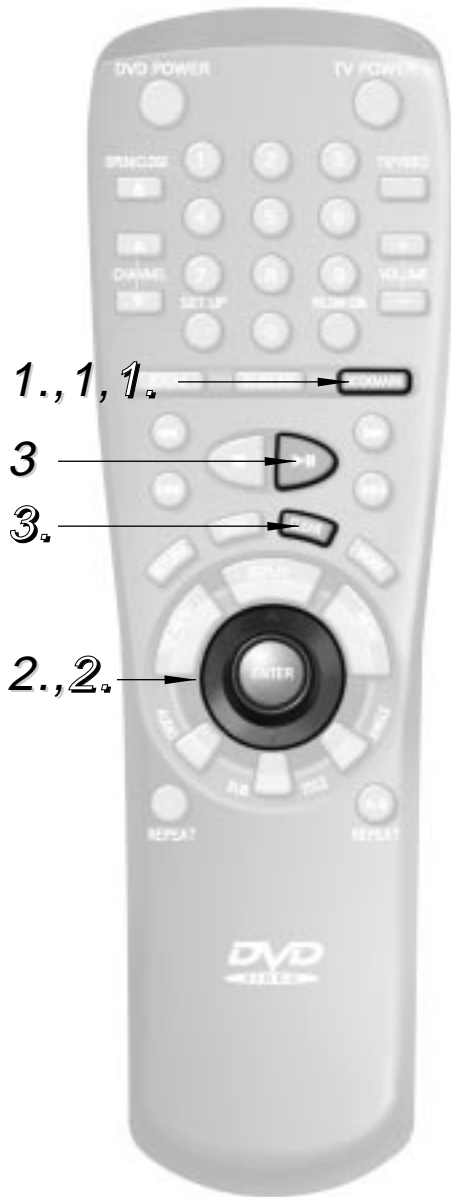

Using the Bookmark Function (DVD/VCD)

1. During playback, press the BOOKMARK button on the remote. Then 'MARKER' will be displayed.

MARKER: ◀ --- ▶ MARK [ENTER]

2. Use the LEFT/RIGHT button to move to the desired bookmark icon.
3. When you reach the scene you want to mark, press the ENTER button. The icon will change to a number (1, 2, or 3).
4. Press the BOOKMARK button to turn off the display.

Recalling a Marked Scene

1. During playback, press the BOOKMARK button on the remote.
2. Use the LEFT/RIGHT button to select a marked scene.
3. Press the PLAY/PAUSE button to skip to the marked scene.

Clearing a Bookmark

1. During playback, press the BOOKMARK button on the remote.
2. Use the LEFT/RIGHT button to select the bookmark number you want to delete.
3. Press the CLEAR button to delete a bookmark number. Press the BOOKMARK button to turn off display.

NOTE

- Up to three scenes may be marked at the same time.
- When in VCD 2.0 mode (MENU ON mode), this function does not work.
- Depending on the disc, the Bookmark function may not work.

Using the Zoom and 3D Sound

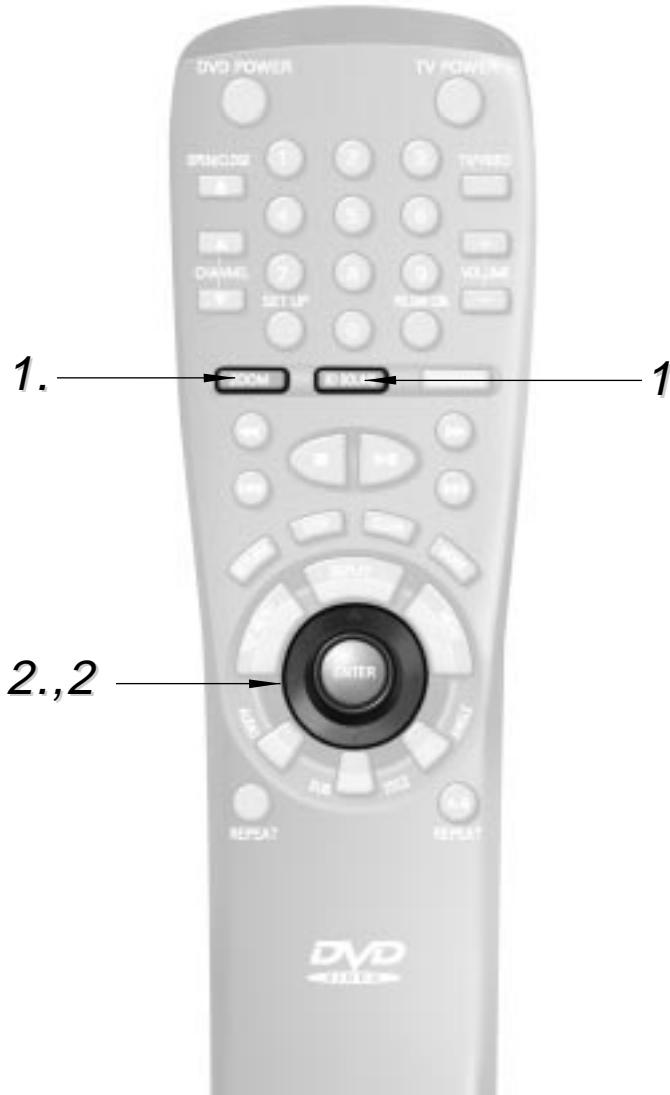

Using the Master Volume Control Function

Press the **VOLUME CON.** button. Use the **UP/DOWN** button to select a suitable volume.

- Master Volume Control function lets you adjust the volume of the player's output. This is useful for matching the player's output level to other equipment in your system.
- Master Volume Control function on CD titles with DTS will not work under **VOLUME : 96** level.
- When the **DIGITAL OUTPUT** is set to **BITSTREAM** in the **SETUP MENU**, the Volume Control function will not work.

NOTE

- 3D Sound is possible only on discs recorded using **DOLBY SURROUND** or **DOLBY DIGITAL**. However, some of these discs do not contain rear channel sound signals.
- Depending on the disc, the Zoom and 3D Sound function may not work.
- Certain audio feature of this product manufactured under a license from Desper Products, Inc., Spatializer® and circle-in-square are trademarks owned by Desper Products Inc.

Using the Zoom Function (DVD/VCD)

1. During playback or pause mode, press the **ZOOM** button on the remote. The square frame will be displayed on screen.
2. Use the **UP/DOWN** or **LEFT/RIGHT** button to select the part of the screen you want to zoom.
3. Press the **ENTER** button.

- During DVD playback, press **ENTER** to zoom in **2X/4X**/normal in order.
- During VCD playback, press **ENTER** to zoom in **2X**/normal in order.

Using the 3D Sound Function

The simulated surround effect (**SPATIALIZER N-2-2**) depends on the disc contents. If you connect the unit to your stereo system, you can enhance sound quality and produce a greater surround effect. This feature is useful when you are using the DVD player with a two channel stereo through the analog outputs.

(Discs which are recorded with **LPCM** or **DTS** will not work. When the **DIGITAL OUTPUT** is set to **BITSTREAM** in the **SETUP MENU**, the 3D Sound function will not work.)

1. During playback, press the **3D SOUND** button. The **3D SOUND** mark will be displayed on screen. (Be sure the **DIGITAL OUTPUT** is set to **PCM**.)
2. Press the **LEFT/RIGHT** button to turn the 3D Sound feature on or off.

Using the Setup Menu

The Setup menu lets you customize your DVD player by allowing you to select various language preferences, set up a parental level, even adjust the player to the type of television screen you have (i.e. widescreen).

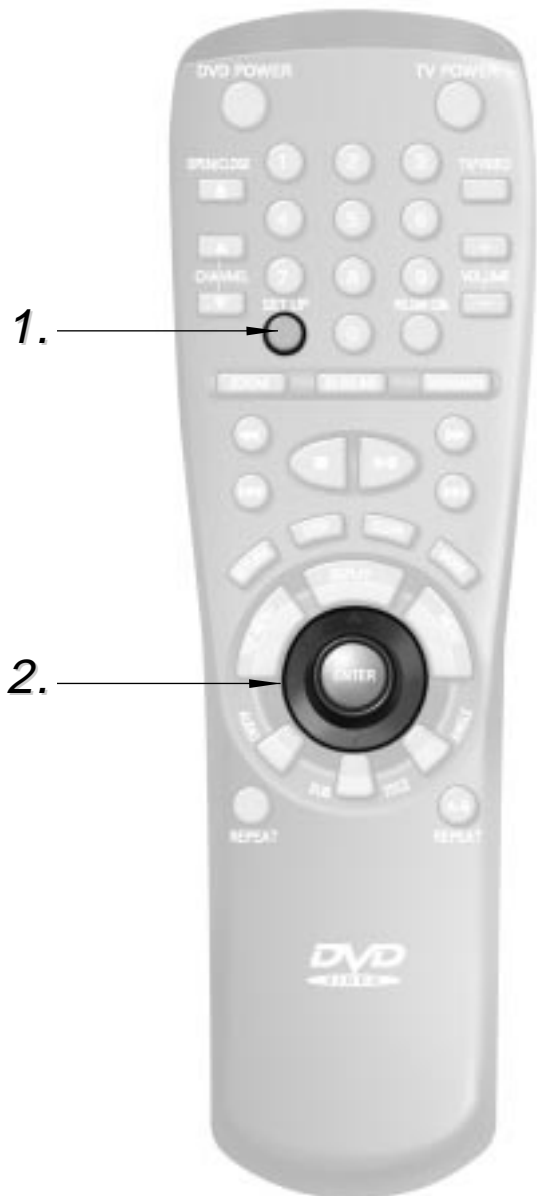

1. Press the SETUP button on the remote in the play or stop mode.

SETUP MENU	
1	PLAYER MENU ENGLISH
2	DISC MENU ENGLISH
3	AUDIO ENGLISH
4	SUBTITLE AUTOMATIC
5	PARENTAL UNLOCKED 
6	AUDIO OPTIONS
7	DISPLAY OPTIONS

RETURN  ENTER

- 1** PLAYER MENU : Setup of the Display Language (See P32)
 Use the Player preference menu to select the language for the player's on-screen displays.
- 2** DISC MENU : Setup of the Menu Language (See P33)
 Use the Menu preference menu to select the language you want a DVD's disc menu to be displayed in.
- 3** AUDIO : Setup of the Audio Language (See P33)
 Use the Audio preference menu to select the soundtrack language.
- 4** SUBTITLE : Setup of the Subtitle Language (See P33)
 Use the Subtitle preference menu to select the language the disc's subtitles are to be displayed in.
- 5** PARENTAL : Setup of the Parental Level (See P34)
 Allows users to set the level necessary to prevent children from viewing unsuitable movies such as those with violence, X rating, etc.
- 6** AUDIO OPTIONS : Setup of the Audio Options (See P35)
 Use to set up the audio options such as speaker setup.
- 7** DISPLAY OPTIONS : Setup of the Display Options (See P37)
 Use to select which type of screen you want to watch and several display options.

2. Use the UP/DOWN button on the remote to access the different features.

3. Press the ENTER button to access the sub features.

To make the setup screen disappear after setting up, press SETUP button again.

NOTE

Depending on the disc, some SETUP menu selections may not work.

Setting Up the Language Features

If you set the player menu, disc menu, audio and subtitle language in advance, it will come up automatically every time you watch a movie.

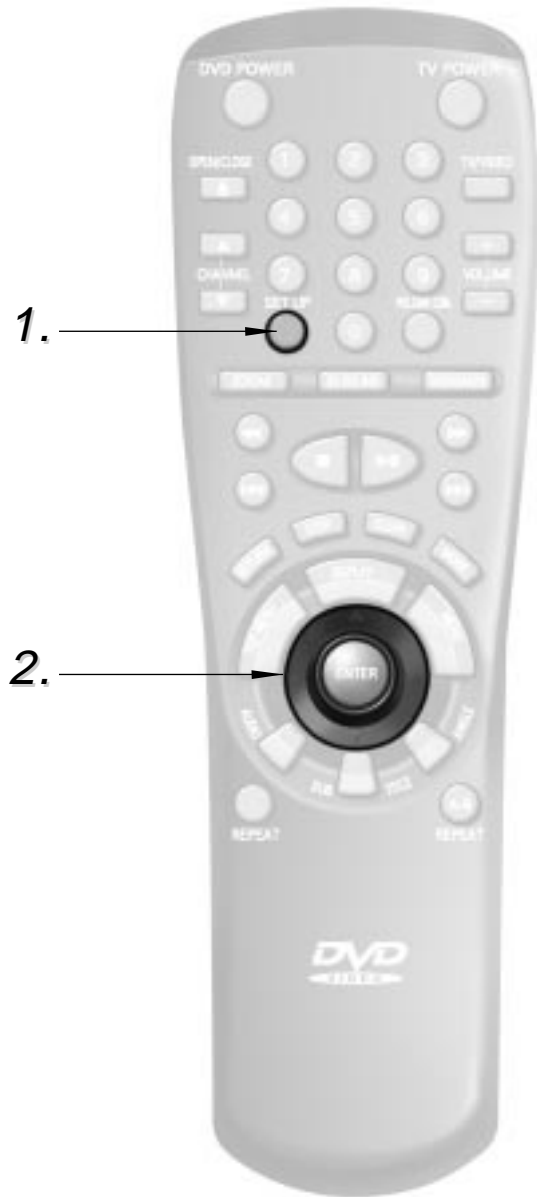

Using the Player Menu

e.g Setting up in ENGLISH.

- 1.** Press the SETUP button when in play or stop mode.
- 2.** Use the UP/DOWN button to select the **PLAYER MENU**.

SETUP MENU	
1	PLAYER MENU ENGLISH
2	DISC MENU ENGLISH
3	AUDIO ENGLISH
4	SUBTITLE AUTOMATIC
5	PARENTAL UNLOCKED
6	AUDIO OPTIONS
7	DISPLAY OPTIONS

RETURN ENTER

- 3.** Press the ENTER button.
- 4.** Use the UP/DOWN button to select 'ENGLISH'.

PLAYER MENU LANGUAGE	
1	ENGLISH
2	FRANCAIS
3	DEUTSCH
4	ESPAÑOL
5	ITALIANO
6	NEDERLANDS

RETURN ENTER

- 5.** Press the ENTER button.

- ENGLISH is selected and the screen returns to SETUP MENU
- To make the SETUP MENU disappear, press the RETURN button.

Setting Up the Language Features (Cont d)

Using the Disc Menu Language

This function changes the language only for the text on the disc menu screens.

e.g Setting up in ENGLISH.

- 1** Press the SETUP button when in play or stop mode.
- 2** Use the UP/DOWN button to select DISC MENU.
- 3** Press the ENTER button.
- 4** Use the UP/DOWN button to select 'ENGLISH'.



- Select "OTHERS" if the language you want is not listed.

- 5** Press the ENTER button.

- ENGLISH is selected and the screen returns to SETUP MENU.

Using the Audio Language

e.g Setting up in ENGLISH.

- 1** Press the SETUP button when in play or stop mode.
- 2** Press the UP/DOWN button to move to AUDIO.
- 3** Press the ENTER button.
- 4** Press the UP/DOWN button to select 'ENGLISH'.



- Select "ORIGINAL" if you want the default soundtrack language to be the original language the disc is recorded in.

- Select "OTHERS" if the language you want is not listed.

- 5** Press the ENTER button.

- ENGLISH is selected and the screen returns to SETUP MENU.

Using the Subtitle Language

e.g Setting up in ENGLISH.

- A** Press the SETUP button when in play or stop mode.
- B** Use the UP/DOWN button to select SUBTITLE.
- C** Press the ENTER button.
- D** Use the UP/DOWN button to select 'ENGLISH'.

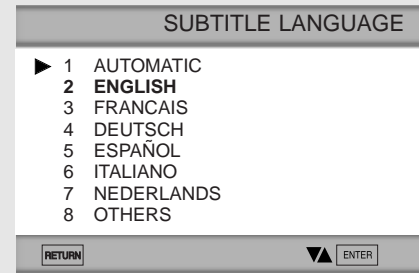

- Select "AUTOMATIC" if you want the subtitle language to be the same as the language selected as the audio preference.

- Select "OTHERS" if the language you want is not listed. Some discs may not contain the language you select as your initial language; in that case the disc will use its original language setting.

- E** Press the ENTER button.

- ENGLISH is selected and the screen returns to SETUP MENU.

How to make the SETUP MENU disappear or return to menu screen during set up.

Press RETURN button.

NOTE If the selected language is not recorded on the disc, the original pre-recorded language is selected.

Setting Up the Parental Level

The Parental Level function works in conjunction with DVDs that have been assigned a rating - which helps you control the types of DVDs that your family watches. There are up to 8 rating levels on a disc.

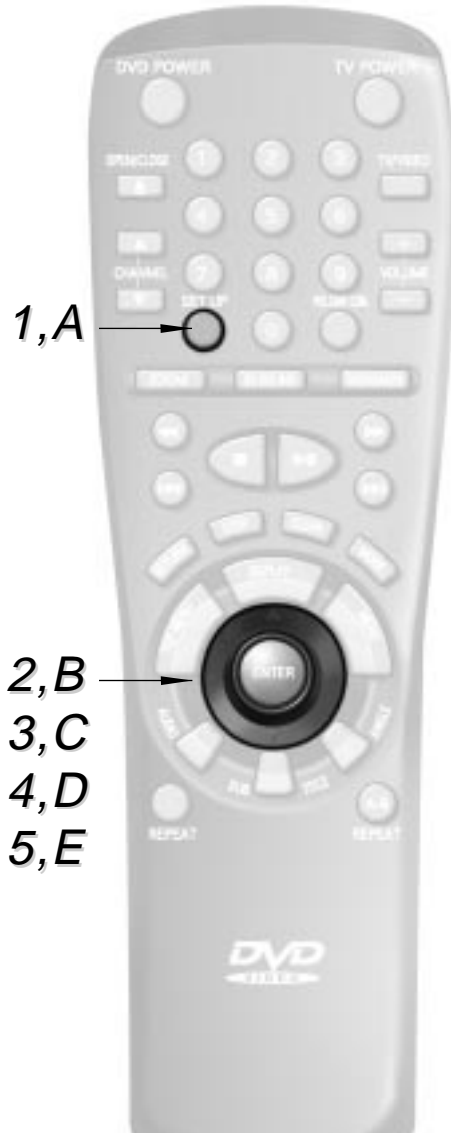

SETTING THE PASSWORD

1. Press the SETUP button when in play or stop mode.
 2. Press the UP/DOWN button to select PARENTAL.
 3. Press the ENTER button and enter your 4-digit password by pressing the 0-9 button.
- '7777' is the original password that has been encrypted in the player.
4. Move to CHANGE PASSWORD by using the UP/DOWN button and press the ENTER button.

PARENTAL CONTROL

- 1 RATING LEVEL
- 2 CHANGE PASSWORD

5. Enter the new password.

- After entering the new password, re-enter it one more times to make sure the password works.
- The Parental Level function is compatible only with parental level encoded discs.

SETTING THE PARENTAL LEVEL

e.g. Setting up in LEVEL 6

- A. Press the SETUP button when in play or stop mode.
- B. Press the UP/DOWN button to select PARENTAL.
- C. Press the ENTER button and enter your 4-digit password by pressing the 0-9 button.
- D. Move to the RATING LEVEL by using the UP/DOWN button and press the ENTER button.

PARENTAL CONTROL

- 1 RATING LEVEL
- 2 CHANGE PASSWORD

- E. Move to LEVEL 6 by using the UP/DOWN button and press the ENTER button.
- The disc which contains LEVEL 7 or LEVEL 8 will now not play.

RATING LEVEL

UNLOCK
 LOCK LEVEL 8 ADULT
 LEVEL 7
 LEVEL 6
 LEVEL 5
 LEVEL 4
 LEVEL 3
 LEVEL 2
 LEVEL 1 KIDS SAFE

NOTE

- What if a DVD's rating exceeds the player's rating level?
 The player alerts you when you try to play a DVD with a rating that exceeds the level you've set. The message, "YOUR SELECTION EXCEEDS THE RATING LIMIT FOR THIS PLAYER." appears on screen. Some discs are authored with a rating override feature included. When you play a disc with this feature, the message, "Your selection exceeds the rating level for this player. Override the level?" is displayed. Select "Override" or "Cancel." If you choose to override the rating level, you will need to enter your 4-digit password to begin playback.
- If you have forgotten your password, follow this procedure:
 Press power on from a cold start with no disc in the unit. Press the STOP and PLAY buttons simultaneously on the front panel for three seconds. The Select Menu Language display will appear. Select the desired language button. Press the SETUP button on the remote control to select the Parental Mode. The Parental Mode is now unlocked as indicated on the display. Press the DOWN button to select Parental. Press ENTER and the Password Check display will appear. Enter the default password of "7777". You can now set your rating level and change your password to a new number.

How to make the SETUP MENU disappear or return to menu screen during set up.

Press RETURN button.

Setting Up Audio Options

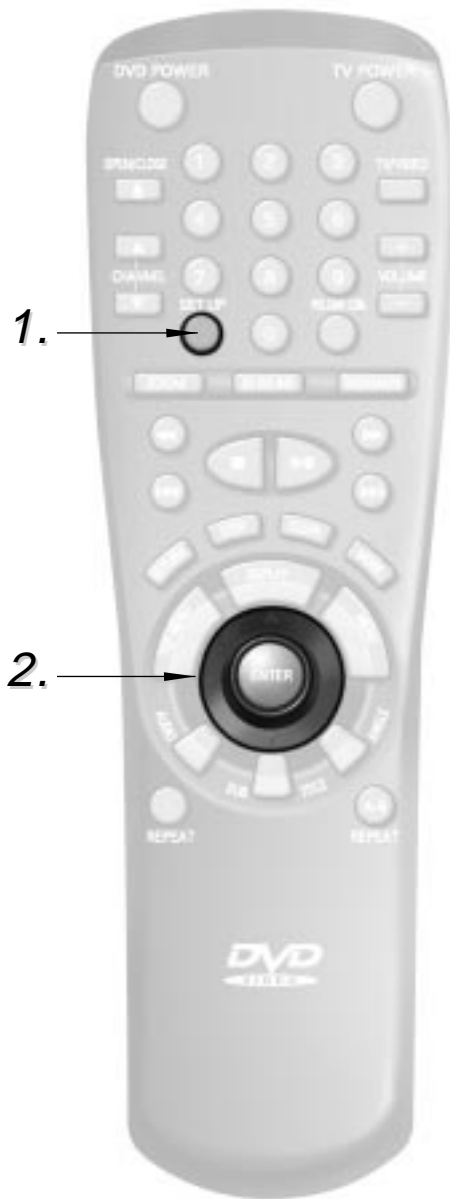

How to make the SETUP MENU disappear or return to menu screen during set up.

Press RETURN button.

1. Press the SETUP button when in play or stop mode.
2. Use the UP/DOWN button to select AUDIO OPTIONS. Then press the ENTER button.
3. Use the UP/DOWN button to select the desired item. Then press the ENTER button.

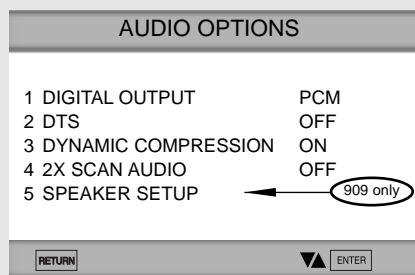

- 1 DIGITAL OUTPUT
A digital surround sound format that is recorded by Dolby Digital. Select the suitable output signal type of digital audio output (Bitstream/PCM) during playback.
- 2 DTS
This program features discrete 5.1 channel sound-track and must be played through DTS-capable equipment. When played through DTS equipment, sound will be heard from all five system speakers and a subwoofer.
- 3 DYNAMIC COMPRESSION
Compresses the dynamic range (quietest to loudest sound) of a disc's soundtrack. This function is disc-dependent, and may not work with all DVDs.
- 4 2X SCAN AUDIO
Turns audio off or on when a disc is in 2X playback mode.

- 5 SPEAKER SETUP (DVD-909 only)
To select the SPEAKER SETUP to hear surround sound.

4. Use the UP/DOWN button to select the desired item. Then press the ENTER button.

- 1 DIGITAL OUTPUT
 - 1 PCM : Converts to PCM(2CH) 48kHz/16Bit audio. Select PCM when using the Analog Audio Outputs.
 - 2 BITSTREAM : Converts to Dolby Digital BITSTREAM (5.1CH). Select BITSTREAM when using the Digital Audio Output.

NOTE : Be sure to select the correct Digital Output or no audio will be heard.

- 2 DTS
 - 1 ON : Outputs DTS BITSTREAM via digital output only. Select DTS when connecting to a DTS DECODER.
 - 2 OFF : Doesn't output digital signal.

- 3 DYNAMIC COMPRESSION
 - 1 ON : To select dynamic compression.
 - 2 OFF : To select the standard range.

- 4 2X SCAN AUDIO
 - 1 ON : Turns 2X audio on.
 - 2 OFF : Turns 2X audio off.

Though 2X SCAN AUDIO is ON in the SETUP MENU, no sound will be heard on discs which are recorded with LPCM, DTS or MPEG-2.

- 5 SPEAKER SETUP
Refer to page 36.

NOTE

• Manufactured under license from Dolby Laboratories. "Dolby", "Pro Logic" and the double-D symbol are trademarks of Dolby Laboratories. Confidential unpublished works. ©1992-1997 Dolby Laboratories Inc. All rights reserved.

Surround Sound Speaker Setup (DVD-909 only)

The DVD-909 has a Speaker Setup feature that allows you to customize your surround sound setup.

1. Press the SETUP button in play or stop mode.
2. Press the UP/DOWN button to select AUDIO OPTIONS. Then press the ENTER button.
3. Use the UP/DOWN button to select SPEAKER SETUP. Then press the ENTER button.

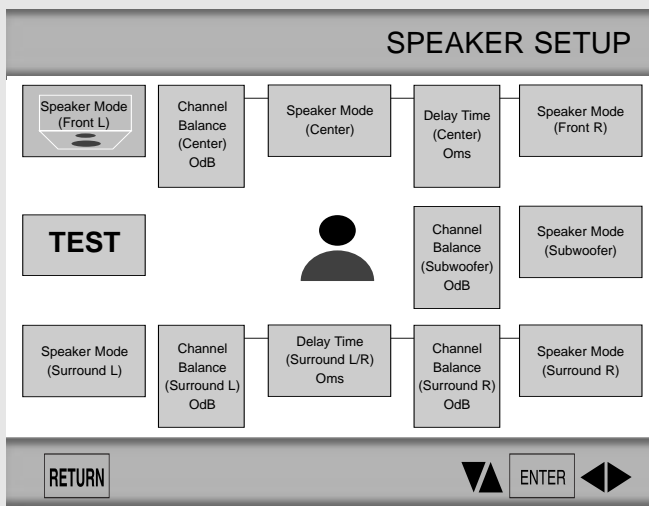

■ SPEAKER MODE

You can set a mode in the system that's currently used. Initially it is set as follows:

- Front speaker (L/R) : Found (Large illustration)
- Center speaker : Not found (No illustration visible)
- Subwoofer : Not found (No illustration visible)
- Surround speaker (L/R) : Not found (No illustration visible)

■ DELAY TIME

You can customize the sound to conform to the acoustics of your room by adding a delay effect to the sound of the Center and Surround Speakers. Initially it is set as "Oms (milliseconds)".

■ TEST

Test signals memorized in the system are sent to each speaker.

■ CHANNEL BALANCE

Adjust the output level of a speaker by using test signals that are memorized in the system. Initially it is set as "OdB".

4. Use the UP/DOWN or LEFT/RIGHT button to select the desired item. Then press the ENTER button.
5. Use the UP/DOWN button to select speaker mode desired. Then press the ENTER button.

■ Setting up SPEAKER MODE

- If you have connected the system to a speaker with low frequencies of 100Hz or below, select 'Found(Large illustration)'.
- If you have connected the system to a speaker without low frequencies of 100Hz or below, select 'Found(Small illustration)'. If you don't connect a subwoofer, always select 'Found(Large illustration)' for the Front Speakers(L/R).
- When you don't have a particular speaker connected, select 'Not found(No illustration visible)'.

■ Setting up DELAY TIME

- When 5.1CH Surround Sound is played, you can enjoy the best sound if the distance between you and each speaker is the same. You can set Delay Time in the Center/Surround Speaker to customize the sound to the acoustic of your room.

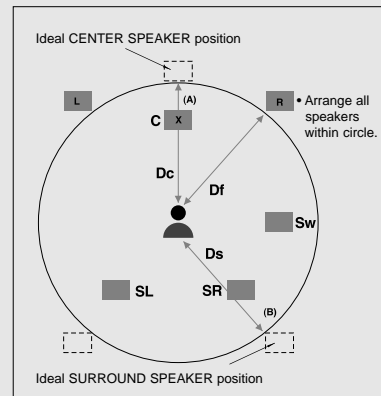

• Setting CENTER SPEAKER

If the distance of D_c is equal to or longer than the distance of D_f in the left figure, set the mode as Oms. Otherwise, change the setting according to the table below.

$$(A) = D_f - D_c$$

Distance of (A)(in)	Setting(ms)
1.64	1.3
3.28	2.6
4.92	3.9
6.56	5.3

• Setting SURROUND SPEAKERS

If the distance of D_f is equal to the distance of D_s in the above, set the mode as Oms. Otherwise, change the setting according to the table on the right.

$$(B) = D_f - D_s$$

Distance of (B)(in)	Setting(ms)
6.56	5.3
13.12	10.6
19.68	15.9

■ Setting up TEST

The test output signals come clockwise starting from the Front Speaker(L). Adjust Channel Balance to match to the volume of test signals memorized in the system.

FRONT(L) → CENTER → FRONT(R) →
SUBWOOFER → SURROUND(R) → SURROUND(L)

How to make the SETUP MENU disappear or return to menu screen during set up.

Press RETURN button.

NOTE

- The subwoofer test output signal is lower than the other speakers.
- The MPEG Multichannel logo is a trademark registered by PHILIPS Corporation.

Setting Up Display Options



1. Press the SETUP button in play or stop mode.
2. Use the UP/DOWN button to select DISPLAY OPTIONS. Then press the ENTER button.
3. Use the UP/DOWN button to select the desired item. Then press the ENTER button.

DISPLAY OPTIONS	
1 TV ASPECT	WIDE
2 ANGLE MARK	ON
3 STILL MODE	AUTO
4 SCREEN MESSAGES	ON
5 FRONT DISPLAY	AUTO
6 BLACK LEVEL	OFF

RETURN ENTER

- ❶ TV ASPECT : Depending on the type of television you have, you may want to adjust the screen setting (aspect ratio).
- ❷ ANGLE MARK : Use to turn on or off the on-screen displays when the DVDs play multiple angles of a particular scene.
- ❸ STILL MODE : Prevent picture shaking in still mode and display small text clearer.
- ❹ SCREEN MESSAGES : Use to turn on-screen messages on or off.
- ❺ FRONT DISPLAY
Adjust the brightness of the unit's front panel display.
- ❻ BLACK LEVEL

4. Use the UP/DOWN button to select the desired item. Then press the ENTER button.

❶ TV ASPECT

❶ 4:3 LETTER BOX :

Select when you want to see the total 16:9 ratio screen DVD supplies, even though you have a TV with a 4:3 ratio screen. Black bars will appear at the top and bottom of the screen.

❷ 4:3 PAN-SCAN :

Select this for conventional size TVs when you want to see the central portion of the 16:9 screen. (Extreme left and right side of movie picture will be cut off.)

❸ 16:9 WIDE :

You can view the full 16:9 picture in your widescreen TV.

❷ ANGLE MARK

❶ ON : Displays ANGLE MARK in the upper right corner of screen.

❷ OFF : Doesn't display it.

❸ STILL MODE

❶ FIELD : Select this feature when the screen shakes in the AUTO mode.

❷ FRAME : Select this feature when you want to see small letters more clearly in the AUTO mode.

❸ AUTO : When selecting AUTO, FIELD/FRAME mode will be automatically converted.

❹ SCREEN MESSAGES

Use this feature to turn the on-screen displays on or off that appear in screen.

❺ FRONT DISPLAY

❶ BRIGHT : It makes the Front Panel Display bright.

❷ DIM : It makes the Front Panel Display dim.

❸ AUTO DIM : It makes the Front Panel Display dim automatically when playing a DVD.

❻ BLACK LEVEL

Adjust the brightness of screen.

Controlling a TV with the Remote

The remote can also be set up to control most TVs. To program the remote, use the code that corresponds to your brand.



1. Turn on the TV.
2. Point the DVD's remote at the TV.
3. While holding the TV POWER button down, enter the code for your brand.

TV Codes			
CODE	BRAND	CODE	BRAND
0	SAMSUNG A	OPEN/CLOSE	MITSUBISHI
1	SHARP B	AUDIO	SAMSUNG B
2	SONY	SUB TITLE	SAMSUNG C
3	MAGNAVOX	DVD POWER	SHARP A
4	SANYO A	ANGLE	ZENITH
5	LG B	TOP MENU	LG C
6	RCA	MENU	DAEWOO
7	LG A	RETURN	SANYO B
8	TOSHIBA	REV SEARCH	EMERSON
9	HITACHI	REPEAT	SHARP C
SETUP	JVC	FWD SEARCH	SAMSUNG D
DISPLAY	PANASONIC A	BACK SKIP	PANASONIC B

e.g For Samsung A TVs

While holding down the TV button, enter 0.

4. If the TV turns off, setup is complete.

Enter other codes of the same brand if the first code does not work.

5. To operate the TV, use the "TV Function Buttons" described on page 13.

NOTE The remote may not be able to control every model TV of the brands listed.

Troubleshooting Guide

Proper function of your DVD player is mostly dependent on the discs you play. When some of the functions indicated in the I/B do not work properly, it is highly probable that the disc is responsible. We strongly recommend you review the instruction book before you start using the player. For your convenience, we have enlisted some tips to help solve problems you might encounter while using the DVD player. However, if the same problem occurs repeatedly, please contact your nearest service center.

Problem	Action	I/B
No operations can be performed with remote.	<ul style="list-style-type: none"> • Check the batteries in the remote. May need replacing. • Operate the remote control at a distance of no more than 20 feet. • Remove batteries and hold down one or more buttons for several minutes to drain the microprocessor inside the remote to reset it. Reinstall batteries and try remote again. 	P 13
Disc does not play	<ul style="list-style-type: none"> • Ensure that the disc is installed with the label side facing up. • Check the region number of the DVD. • This player cannot play CD-ROMs, DVD-ROMs, CD-R, etc. Insert a DVD, a VIDEO-CD or a CD. 	P 7, 18, 19
5.1 channel sound is not being reproduced.	<ul style="list-style-type: none"> • 5.1 channel sound is reproduced only when the following conditions are met. : 1)The DVD player is connected with the proper amplifier 2)The disc is recorded with 5.1 channel sound. • Check whether the disc being played has the "Dolby 5.1 ch" mark on the outside. • Check if your audio system is connected and working properly. 	P 7, 15, 17, 35, 36
The  icon appears on screen.	<ul style="list-style-type: none"> • The features or action cannot be completed at this time because: <ol style="list-style-type: none"> 1. The DVD's software restricts it. 2. The DVD's software doesn't support the feature (e.g., angles). 3. The feature is not available at the moment. 4. You've requested a title or chapter number or search time that is out of range. 	P 13, P 22 ~ 30
Disc Menu doesn't appear.	<ul style="list-style-type: none"> • Check if the disc has a Menu. 	P 26 ~ 27
Playback mode differs from the Setup Menu selection	<ul style="list-style-type: none"> • Some of the functions selected in the Setup Menu may not work properly if the disc is not encoded with the corresponding function. 	P 31 ~ 37
The screen ratio cannot be changed.	<ul style="list-style-type: none"> • The Screen Ratio is fixed on your DVDs. 	P 37
No audio	<ul style="list-style-type: none"> • Make sure you have selected the correct Digital Output in the Audio Options Menu. 	P 36
Forgot parental level	<ul style="list-style-type: none"> • With the power on, press and hold the STOP and PLAY/PAUSE button on the player. This resets the password feature and all other settings to the initial factory settings. You may be required to select a menu language. 	P34
If you experience other problems.	<ul style="list-style-type: none"> • Go to the contents and find the section of the instruction book that contains the explanations regarding the current problem, and follow the procedure once again. • If the problem still cannot be solved, please contact your nearest authorized service center or call 1-800-SAMSUNG. 	

Specifications **DVD-909**

General	Power Requirements	AC 120 V, 60 Hz
	Power Consumption	19 W
	Weight	7.5 lbs
	Dimensions	W 16.9 in x D 11.0 in x H 3.5 in
	Operating Temperature Range	+41°F to +95°F
	Operating Humidity Range	10 % to 75 %
Disc	DVD (DIGITAL VERSATILE DISC)	Reading Speed : 11.45 ft/sec.
		Approx. Play Time (Single Sided, Single Layer Disc) : 135 min.
	CD : 5 inches (COMPACT DISC)	Reading Speed : 3.9 to 4.6 ft/sec.
		Maximum Play Time : 74 min.
	CD : 3 1/2 inches (COMPACT DISC)	Reading Speed : 3.9 to 4.6 ft/sec.
		Maximum Play Time : 20 min.
VCD : 5 inches	Reading Speed : 3.9 to 4.6 ft/sec.	
	Maximum Play Time : 74 min. (Video + Audio)	
Video Output	Composite Video	2 channel : 1.0 Vp-p (75 Ω load)
	Component Video	Y : 1.0 Vp-p (75 Ω load)
		Pr : 0.70 Vp-p (75 Ω load)
		Pb : 0.70 Vp-p (75 Ω load)
	S-VIDEO	Luminance Signal : 1.0 Vp-p (75 Ω load)
		Color Signal : 0.286 Vp-p (75 Ω load)
Audio Output	2 channel	L(1/L), R(2/R)
	5.1 channel	F/L, F/R, R/L, R/R, C/T, S/W
	Output Level	Analog : 2 Vrms (1 kHz)
		Digital : 1.15 Vp-p
	*Frequency Response	48 kHz Sampling : 4 Hz to 22 kHz
		96 kHz Sampling : 4 Hz to 44 kHz
	*S/N Ratio	110 dB
	*Dynamic Range	96 dB
*Total Harmonic Distortion	0.003 %	

*: Nominal specification

Specifications **DVD-709**

General	Power Requirements	AC 120 V, 60 Hz
	Power Consumption	17 W
	Weight	7.5 lbs
	Dimensions	W 16.9 in x D 11.0 in x H 3.5 in
	Operating Temperature Range	+41°F to +95°F
	Operating Humidity Range	10 % to 75 %
Disc	DVD (DIGITAL VERSATILE DISC)	Reading Speed : 11.45 ft/sec.
		Approx. Play Time (Single Sided, Single Layer Disc) : 135 min.
	CD : 5 inches (COMPACT DISC)	Reading Speed : 3.9 to 4.6 ft/sec.
		Maximum Play Time : 74 min.
	CD : 3 1/2 inches (COMPACT DISC)	Reading Speed : 3.9 to 4.6 ft/sec.
		Maximum Play Time : 20 min.
VCD : 5 inches	Reading Speed : 3.9 to 4.6 ft/sec.	
	Maximum Play Time : 74 min. (Video + Audio)	
Video Output	Composite Video	1 channel : 1.0 Vp-p (75 Ω load)
	S-VIDEO	Luminance Signal : 1.0 Vp-p (75 Ω load)
		Color Signal : 0.286 Vp-p (75 Ω load)
Audio Output	2 channel	L, R
	Output Level	Analog : 2 Vrms (1 kHz)
		Digital : 0.50 Vp-p
	*Frequency Response	48 kHz Sampling : 4 Hz to 22 kHz
		96 kHz Sampling : 4 Hz to 44 kHz
	*S/N Ratio	110 dB
	*Dynamic Range	96 dB
*Total Harmonic Distortion	0.003 %	

*: Nominal specification

Warranty (for USA users only)

LIMITED WARRANTY TO ORIGINAL PURCHASER

This SAMSUNG brand product, as supplied and distributed by SAMSUNG ELECTRONICS AMERICA, INC. (SAMSUNG) and delivered new, in the original carton to the original consumer purchaser, is warranted by SAMSUNG against manufacturing defects in materials and workmanship for the following limited warranty period:

One (1) Year Parts and Labor

This limited warranty begins on the original date of purchase, and is valid only on products purchased and used in the United States, and does not include transportation, installation, removal or reinstallation. Warranty repairs must be performed by SAMSUNG's authorized service center. To receive warranty service, the original dated bill of sale must be presented upon request as proof of purchase to SAMSUNG or SAMSUNG's authorized service center. Transportation to and from the service center is the responsibility of the purchaser.

SAMSUNG will repair or replace this product, at our option and at no charge with new or reconditioned parts, if found to be defective during the limited warranty period specified above. The product must be returned during the warranty period with transportation charges prepaid to SAMSUNG's designated service center. Prior to returning any product for warranty service, the purchaser must contact SAMSUNG for problem determination and service procedures. SAMSUNG does not warrant uninterrupted or error-free operation of the product. All replaced parts and products become the property of SAMSUNG and must be returned to SAMSUNG. Replacement parts and products assume the remaining original warranty, or ninety (90) days, whichever is longer.

This limited warranty covers manufacturing defects in materials and workmanship encountered in normal, noncommercial use of this product and shall not apply to the following, including, but not limited to: damage which occurs in shipment; applications and uses for which this product was not intended; failures or problems which are caused by products or equipment not supplied by SAMSUNG; accidents, misuse, abuse, neglect, misapplication, fire, water, lightning or other acts of nature; incorrect electrical line voltage, fluctuations or surges; damage caused by improper or faulty installation; improper connection with any peripheral; product alteration or modification; improper or unauthorized repair; cosmetic damage or exterior finish; product with altered serial numbers; failure to follow operating instructions, customer adjustments, maintenance and environmental instructions that are covered and prescribed in the instruction book; use of non-SAMSUNG or unauthorized parts, supplies, accessories or equipment which damage this product or result in service problems; failures or problems due to incompatibility with other equipment.

THERE ARE NO EXPRESS WARRANTIES OTHER THAN THOSE LISTED AND DESCRIBED ABOVE, AND NO WARRANTIES WHETHER EXPRESS OR IMPLIED, INCLUDING, BUT NOT LIMITED TO, ANY IMPLIED WARRANTIES OF MERCHANTABILITY OR FITNESS FOR A PARTICULAR PURPOSE, SHALL APPLY AFTER THE EXPRESS WARRANTY PERIODS STATED ABOVE, AND NO OTHER EXPRESS WARRANTY OR GUARANTY GIVEN BY ANY PERSON, FIRM OR CORPORATION WITH RESPECT TO THIS PRODUCT SHALL BE BINDING ON SAMSUNG. SAMSUNG SHALL NOT BE LIABLE FOR LOSS OF REVENUE OR PROFITS, FAILURE TO REALIZE SAVINGS OR OTHER BENEFITS, OR ANY OTHER SPECIAL, INCIDENTAL OR CONSEQUENTIAL DAMAGES CAUSED BY THE USE, MISUSE OR INABILITY TO USE THIS PRODUCT, REGARDLESS OF THE LEGAL THEORY ON WHICH THE CLAIM IS BASED, AND EVEN IF SAMSUNG HAS BEEN ADVISED OF THE POSSIBILITY OF SUCH DAMAGES. NOR SHALL RECOVERY OF ANY KIND AGAINST SAMSUNG BE GREATER IN AMOUNT THAN THE PURCHASE PRICE OF THE PRODUCT SOLD BY SAMSUNG AND CAUSING THE ALLEGED DAMAGE. WITHOUT LIMITING THE FOREGOING, PURCHASER ASSUMES ALL RISK AND LIABILITY FOR LOSS, DAMAGE OR INJURY TO PURCHASER AND PURCHASER'S PROPERTY AND TO OTHERS AND THEIR PROPERTY ARISING OUT OF THE USE, MISUSE OR INABILITY TO USE THIS PRODUCT SOLD BY SAMSUNG NOT CAUSED DIRECTLY BY THE NEGLIGENCE OF SAMSUNG. THIS LIMITED WARRANTY SHALL NOT EXTEND TO ANYONE OTHER THAN THE ORIGINAL PURCHASER OF THIS PRODUCT, IS NONTRANSFERABLE AND STATES YOUR EXCLUSIVE REMEDY.

Some states do not allow limitations on how long an implied warranty lasts, or the exclusion or limitation of incidental or consequential damages, so the above limitations or exclusions may not apply to you. This warranty gives you specific legal rights, and you may also have other rights which vary from state to state.

To obtain warranty service, please contact SAMSUNG at:

SAMSUNG ELECTRONICS AMERICA, INC. - CONSUMER ELECTRONICS CUSTOMER SERVICE
1 SAMSUNG PLACE, LEDGEWOOD, NJ 07852
Tel: 973-691-6200, Fax: 973-691-6201
1-800-SAMSUNG (1-800-726-7864)
www.sosimple.com

Warranty (for Canada users only)

LIMITED WARRANTY TO ORIGINAL PURCHASER

Samsung Electronics Canada Inc.(SECA), warrants that this product is free from defective material and workmanship.

SECA further warrants that if this product falls to operate properly within the specified warranty period and the failure is due to improper workmanship or defective materials, SECA will repair or replace the product at its option.

All warranty repairs must be performed by a SECA Authorized Service Center. (The name and address of the location nearest you can be obtained by calling toll free: 1- 800- SAMSUNG)

LABOR
One year (Carry- in)

PARTS
One year

On carry-in models, transportation to and from the service center is the customer's responsibility.

The original dated sales receipt must be retained by the customer and is the only acceptable proof of purchase. It must be presented to the authorized service center at the time service is requested.

EXCLUSIONS (WHAT IS NOT COVERED)

This warranty does not cover damage due to accident, fire, flood and/ or other acts of God; misuse, incorrect line voltage, improper installation, improper or unauthorized repairs, commercial use or damage that occurs in shipping. Exterior and interior finish, lamps, glass are not covered under this warranty. Customer adjustments which are explained in the instruction manual are not covered under the terms of this warranty. This warranty will automatically be voided for any unit found with a missing or altered serial number. This warranty is valid only on products purchased and used in Canada.

MEMO

.....